

SICILIA 40

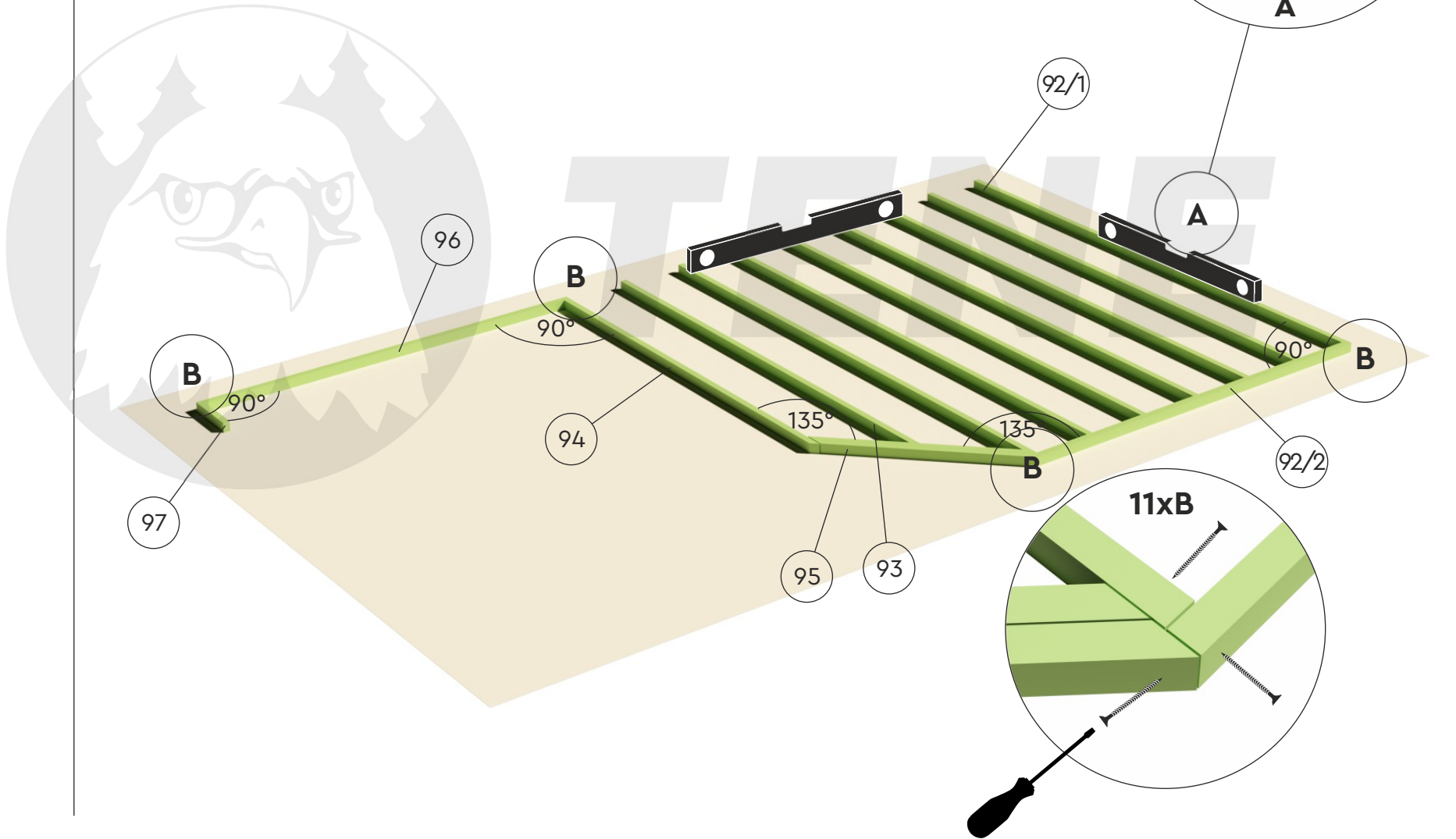

SICILIA 40

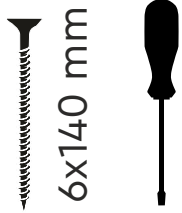

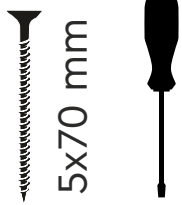
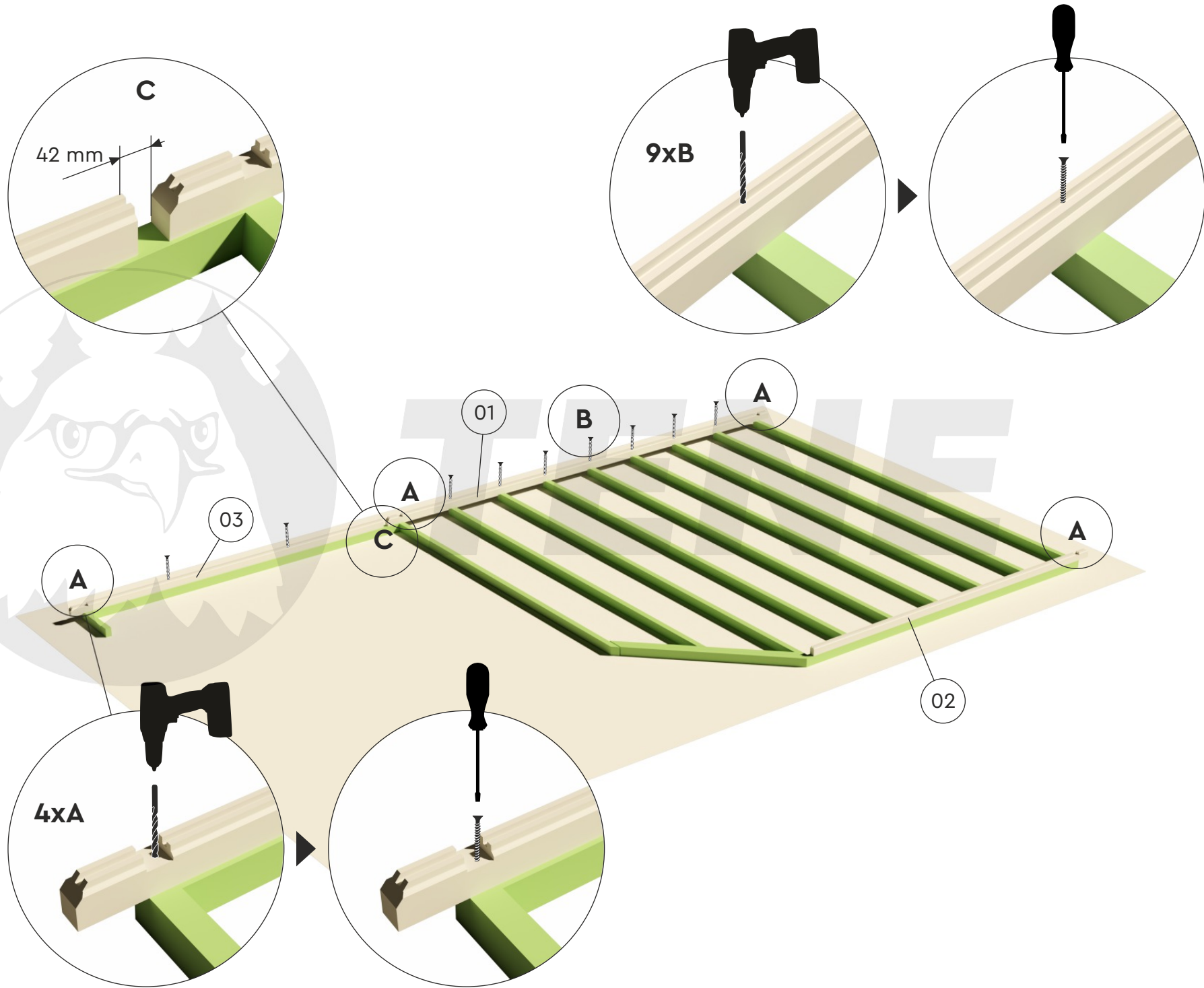
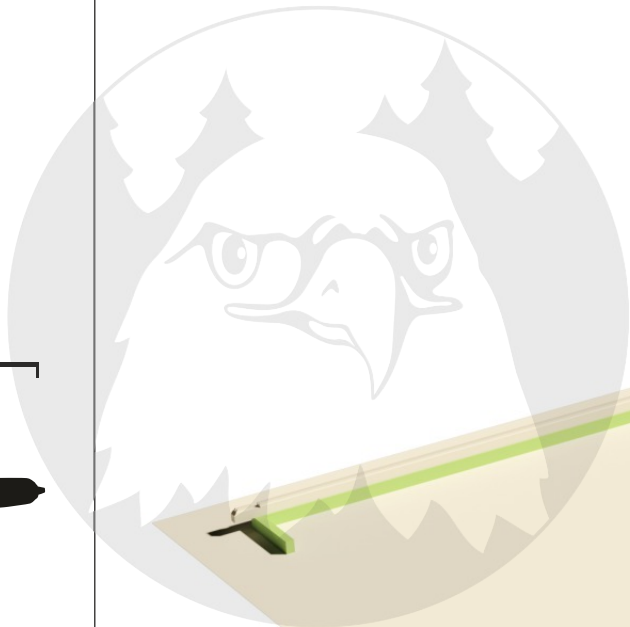
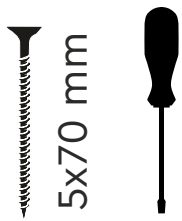

TECHNIFE

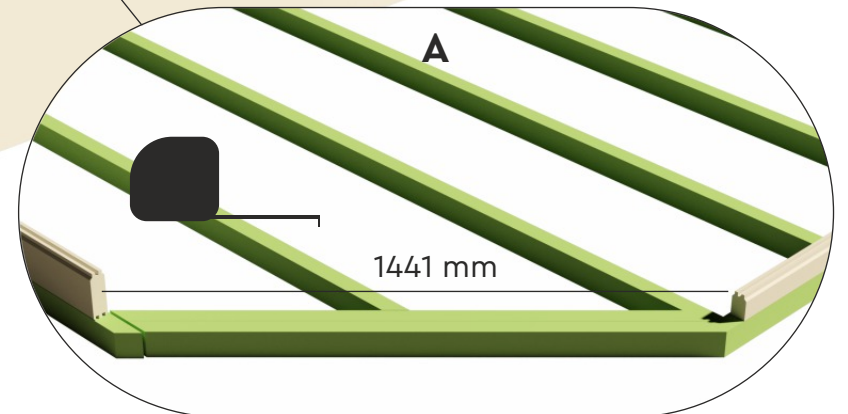
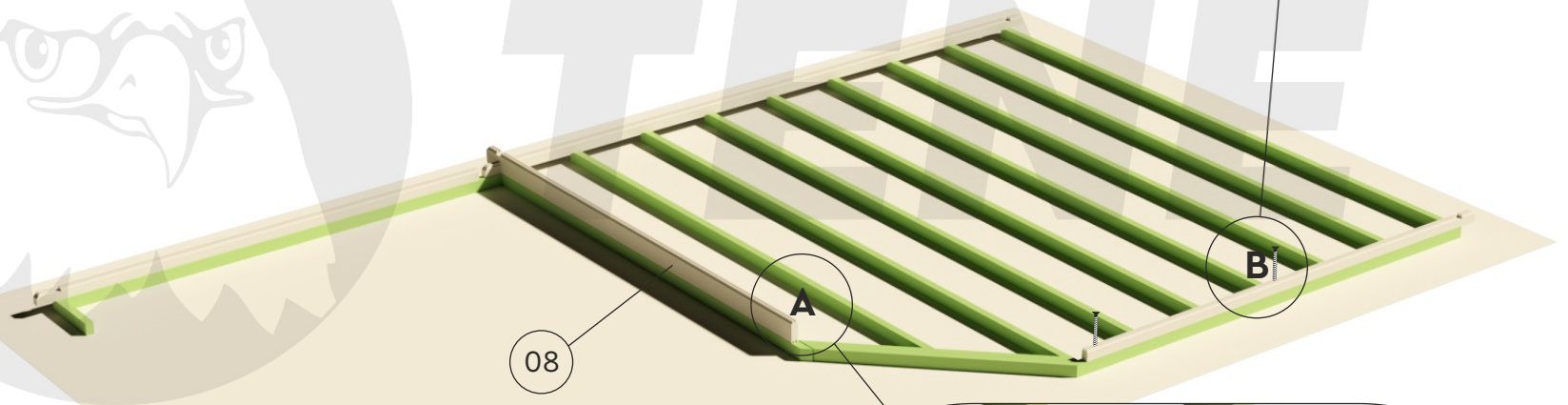
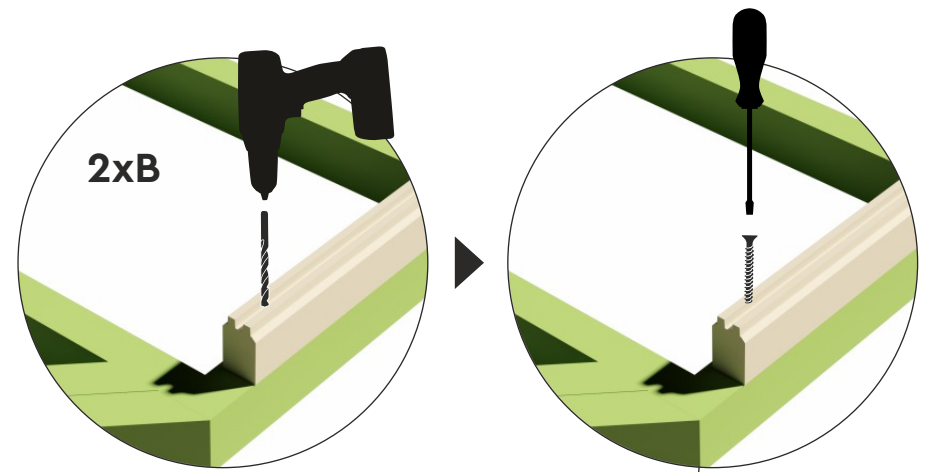

SICILIA 40

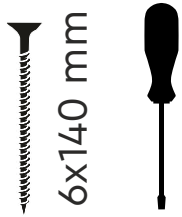
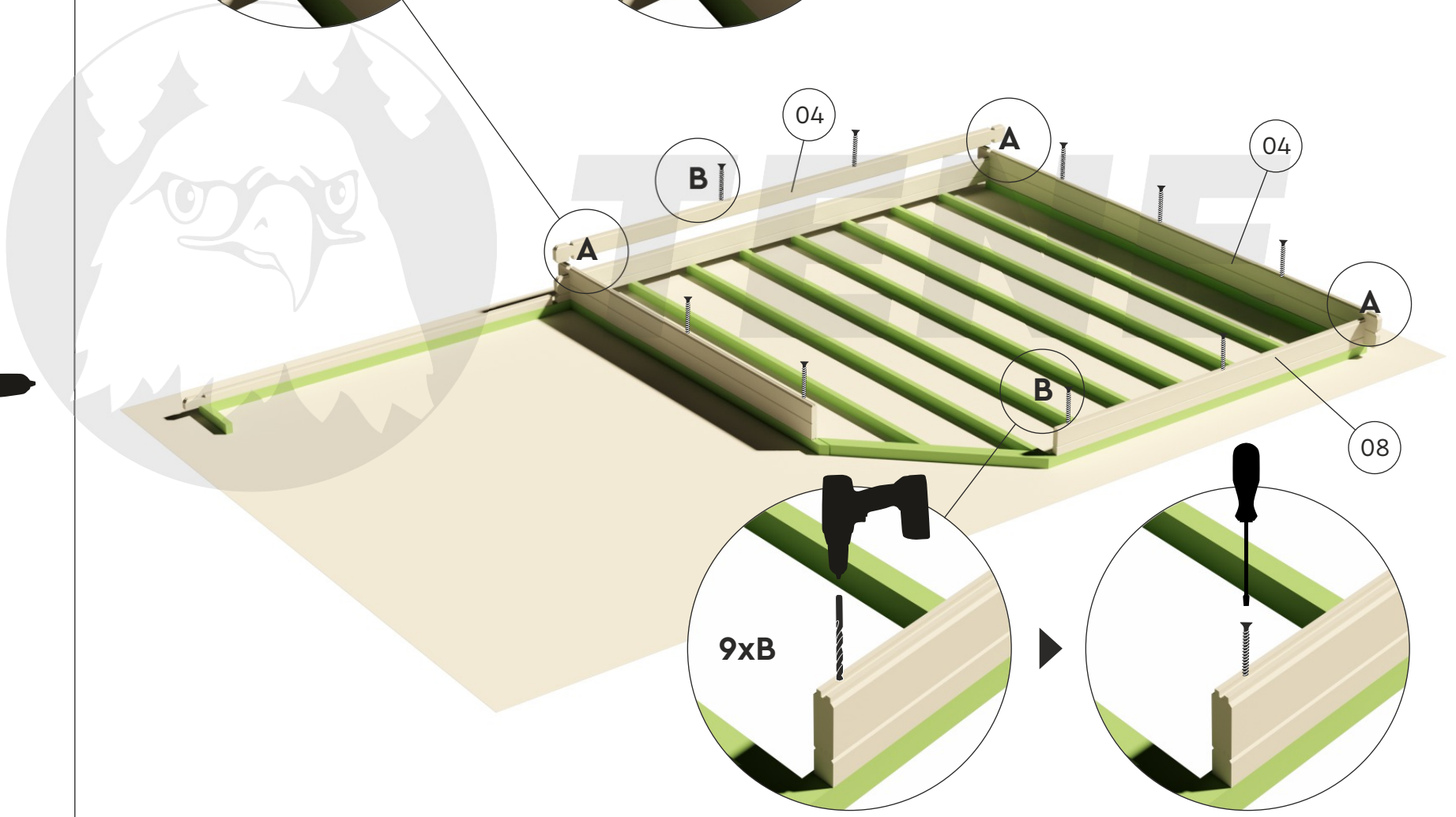
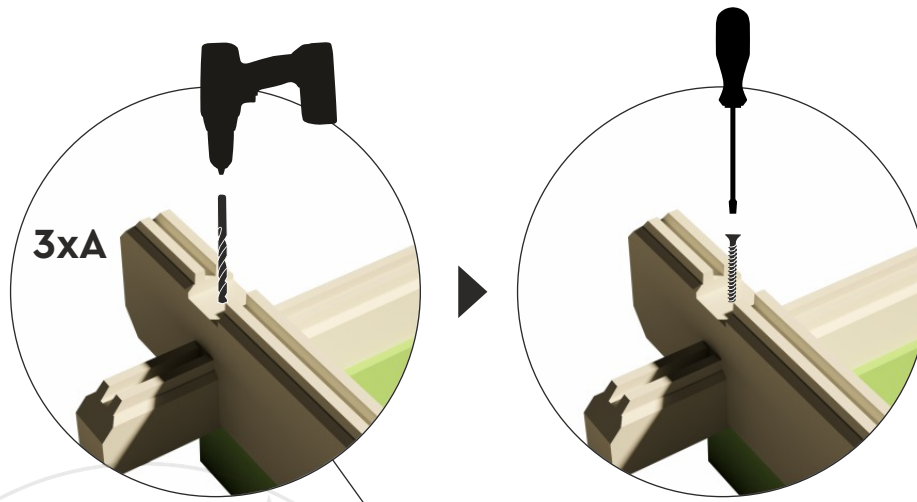

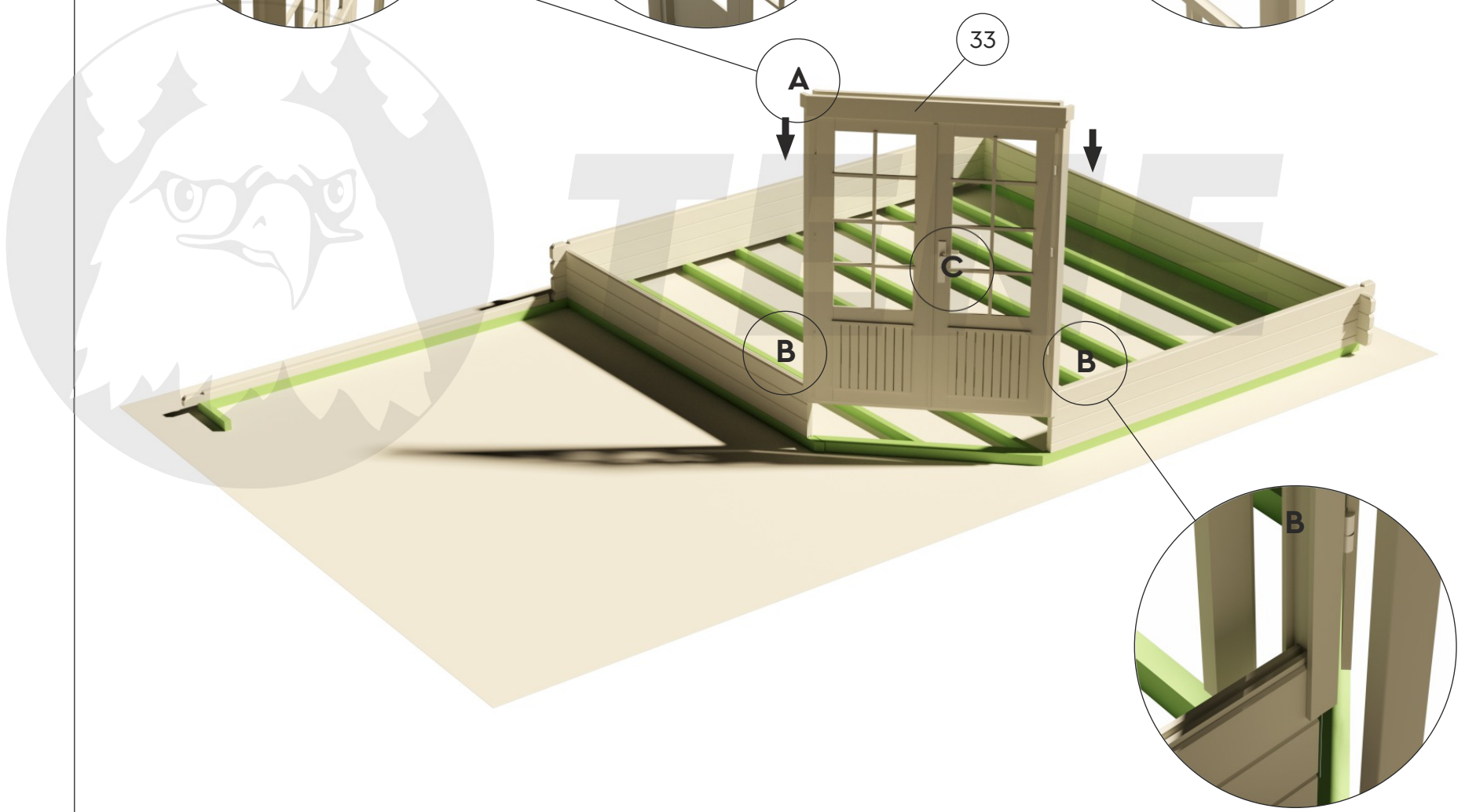
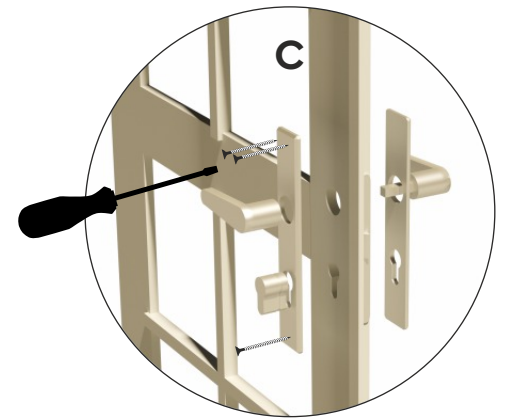
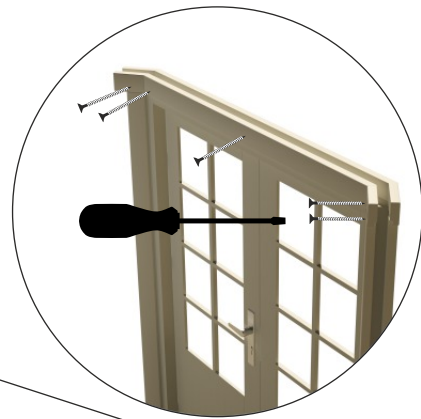
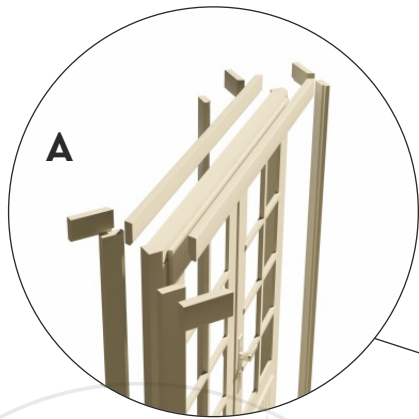

4x40 mm



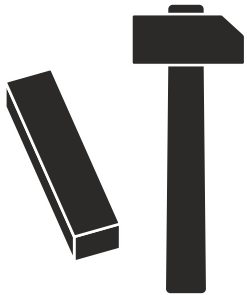
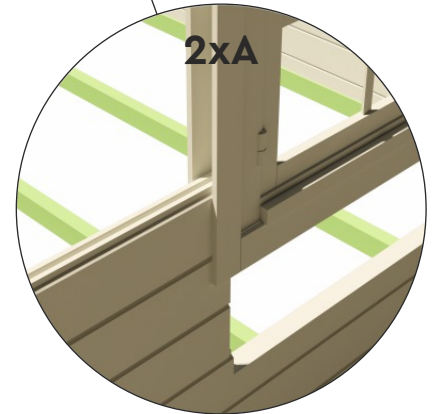
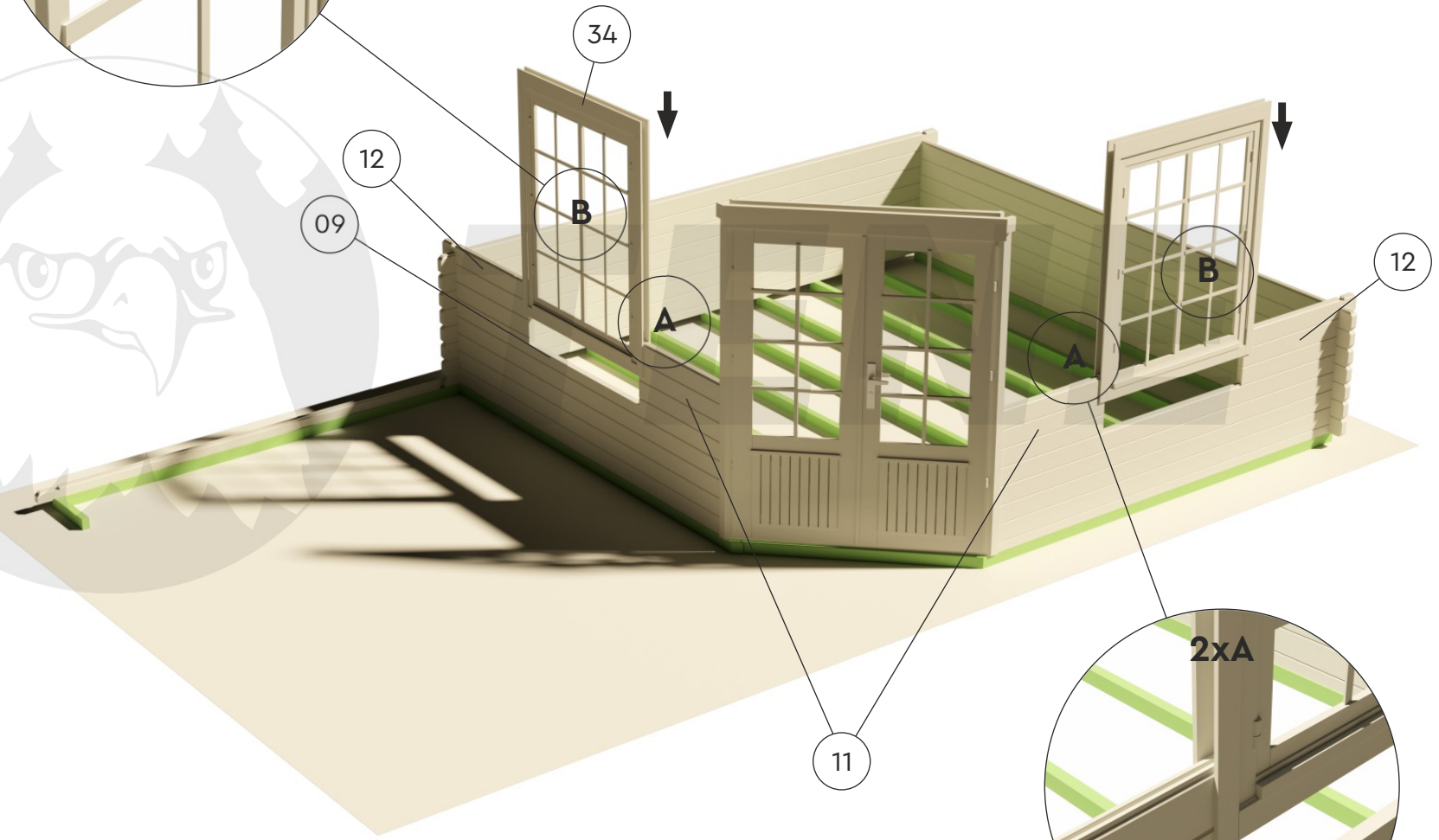
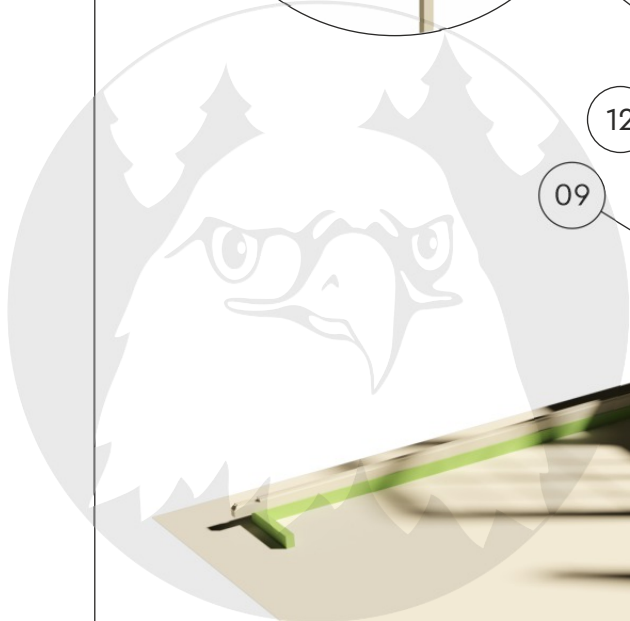
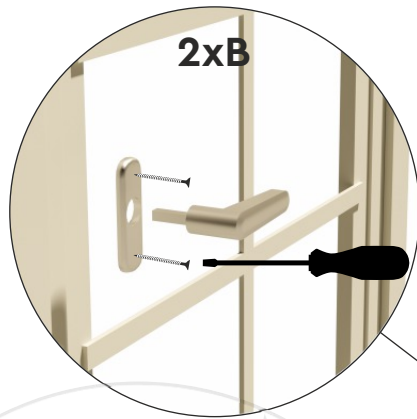

SICILIA 40

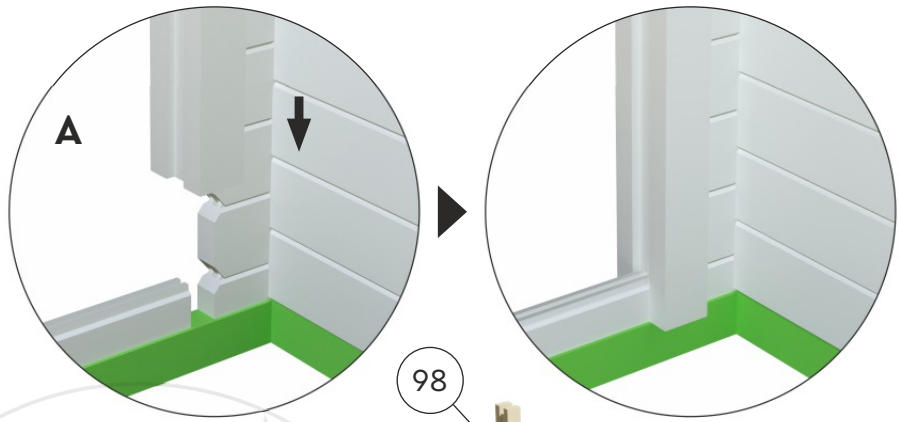

98

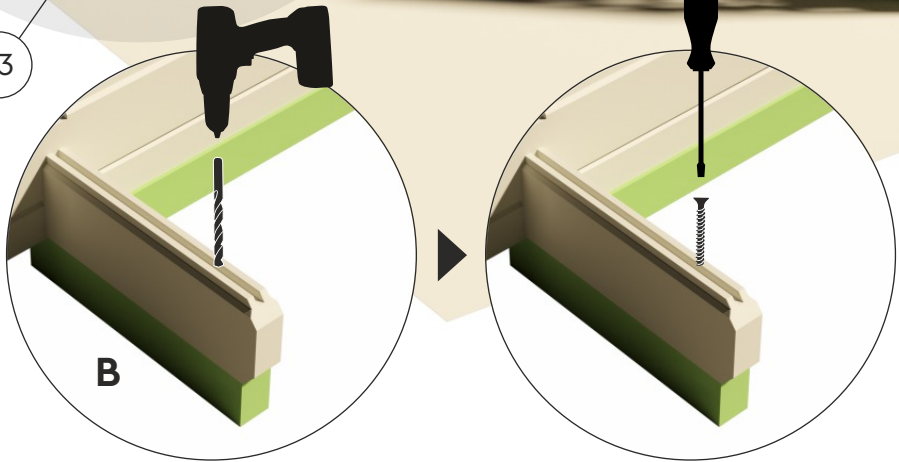
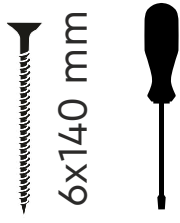
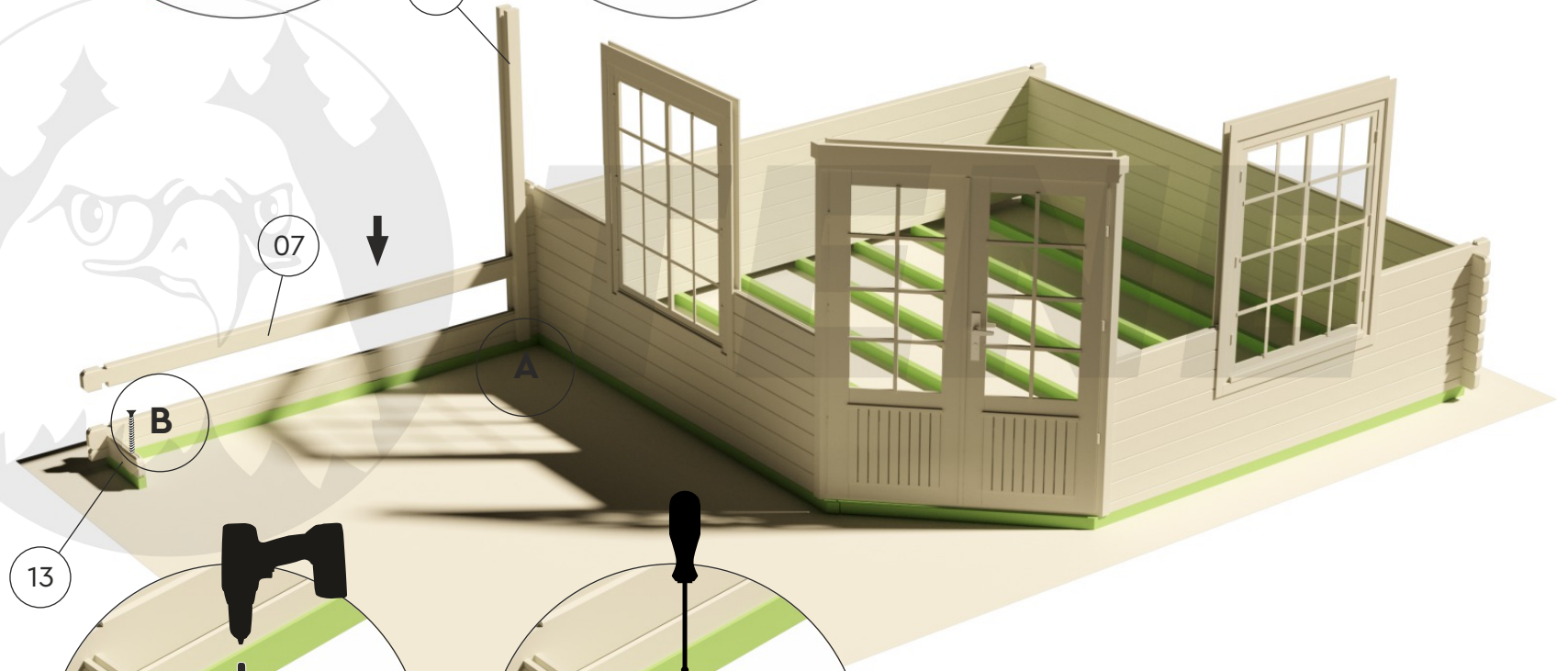



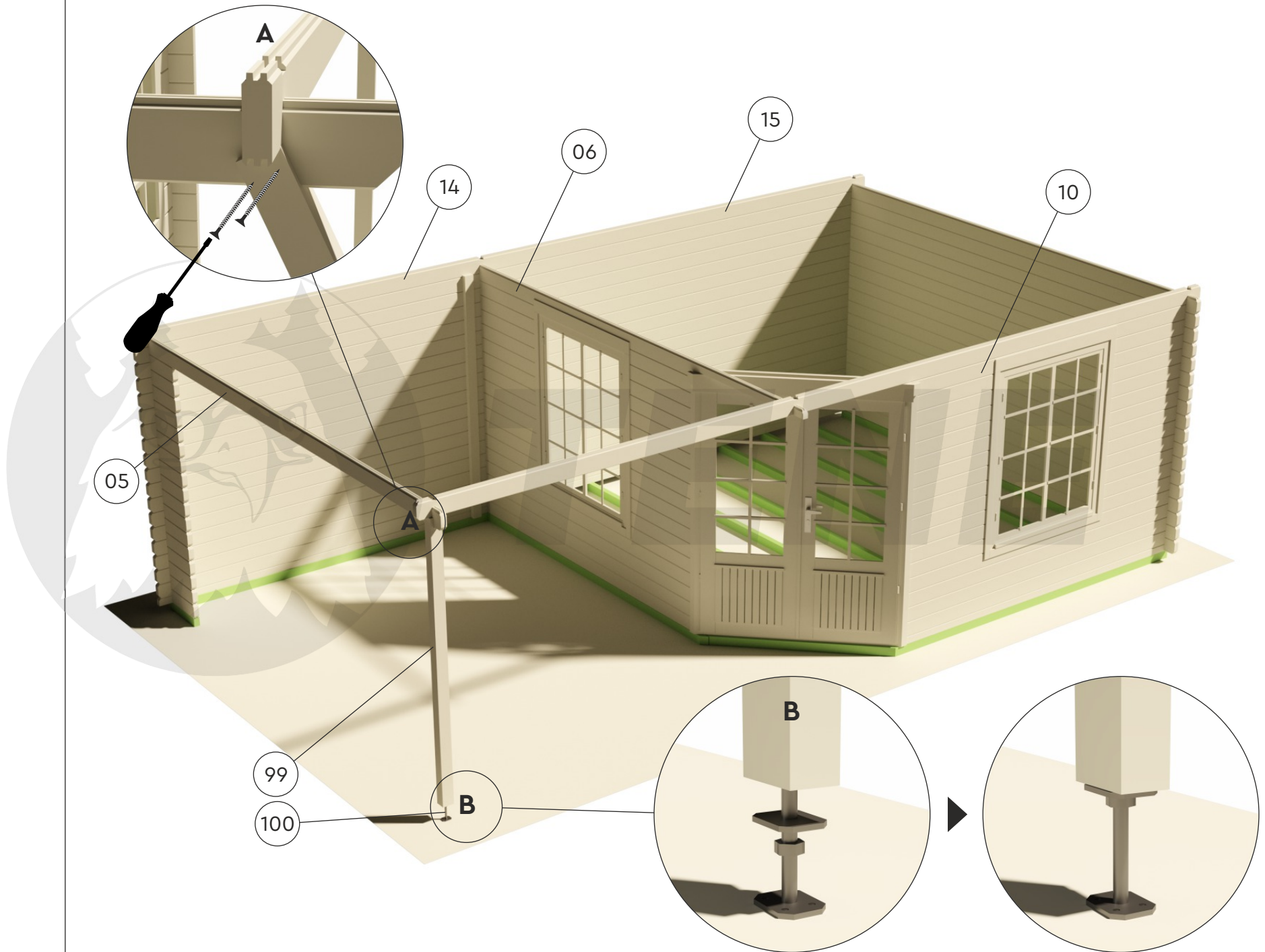



SICILIA 40



4x40 mm



SICILIA 40

-  Ø 5 mm
-  Ø 4 mm
- 
-  6x140 mm
-  4x50 mm
- 

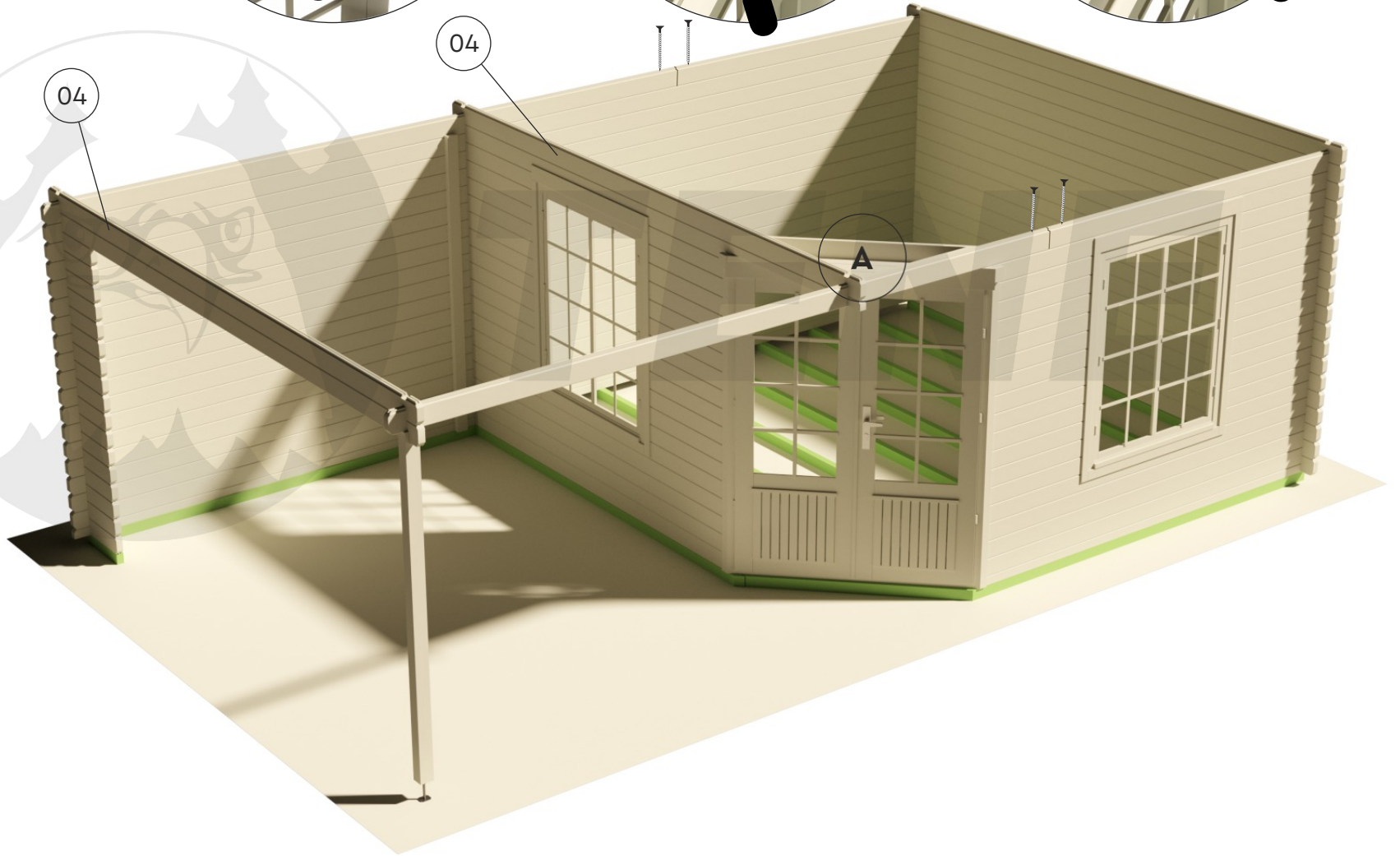
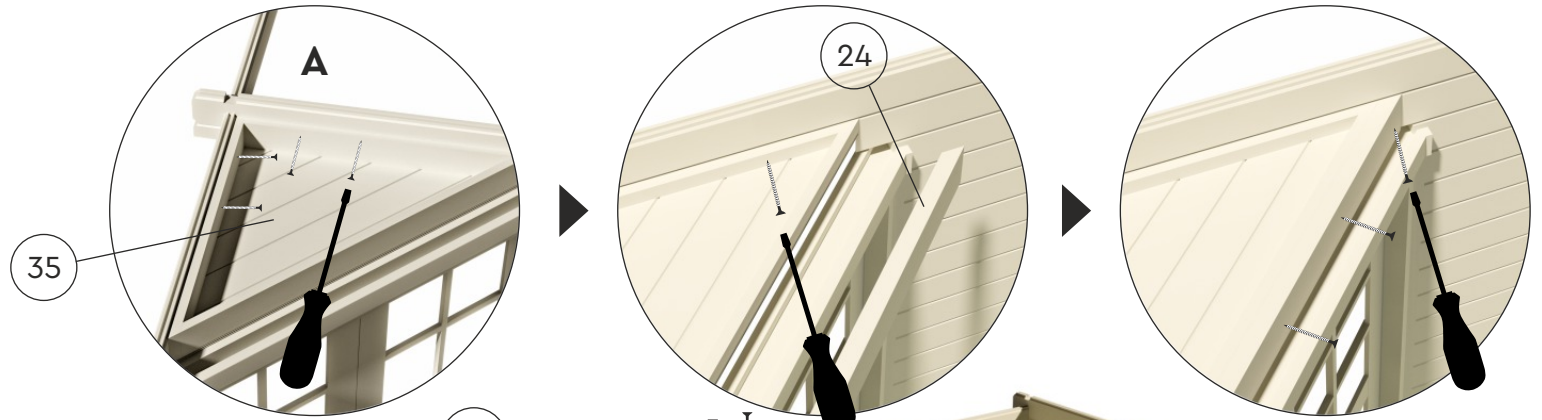

SICILIA 40

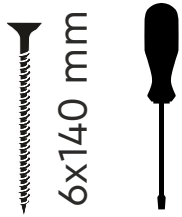
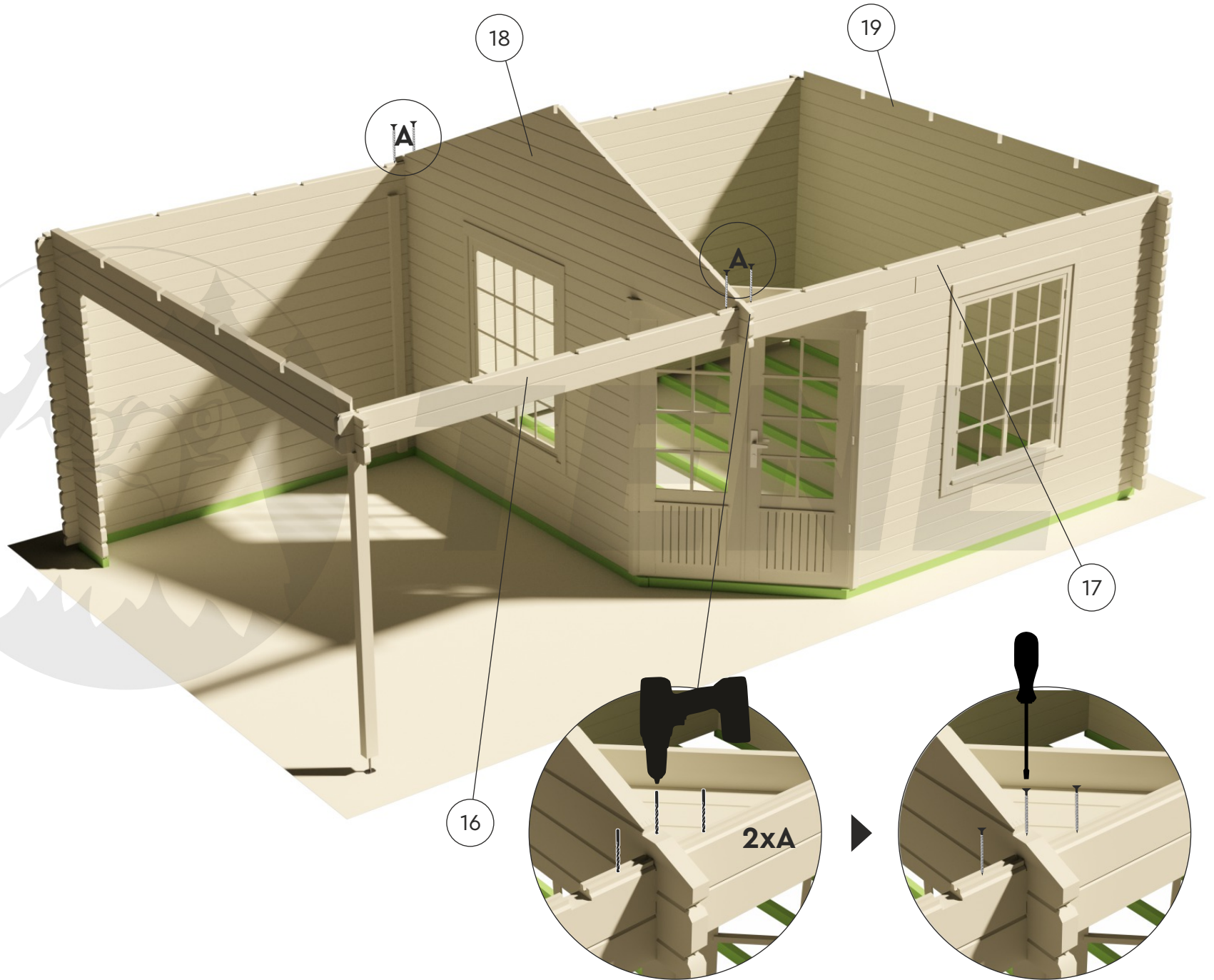

SICILIA 40

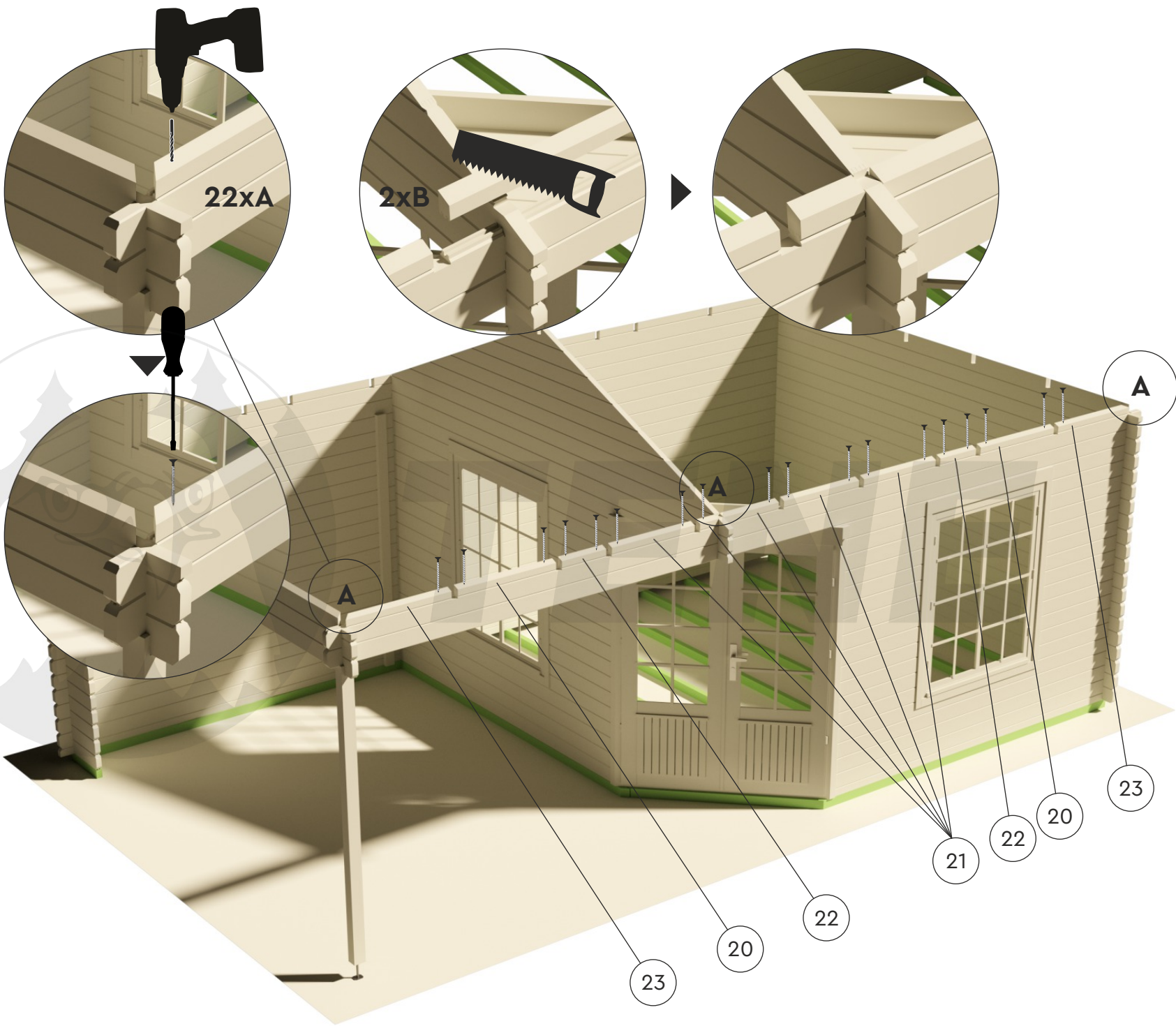

∅ 4 mm



5x70 mm



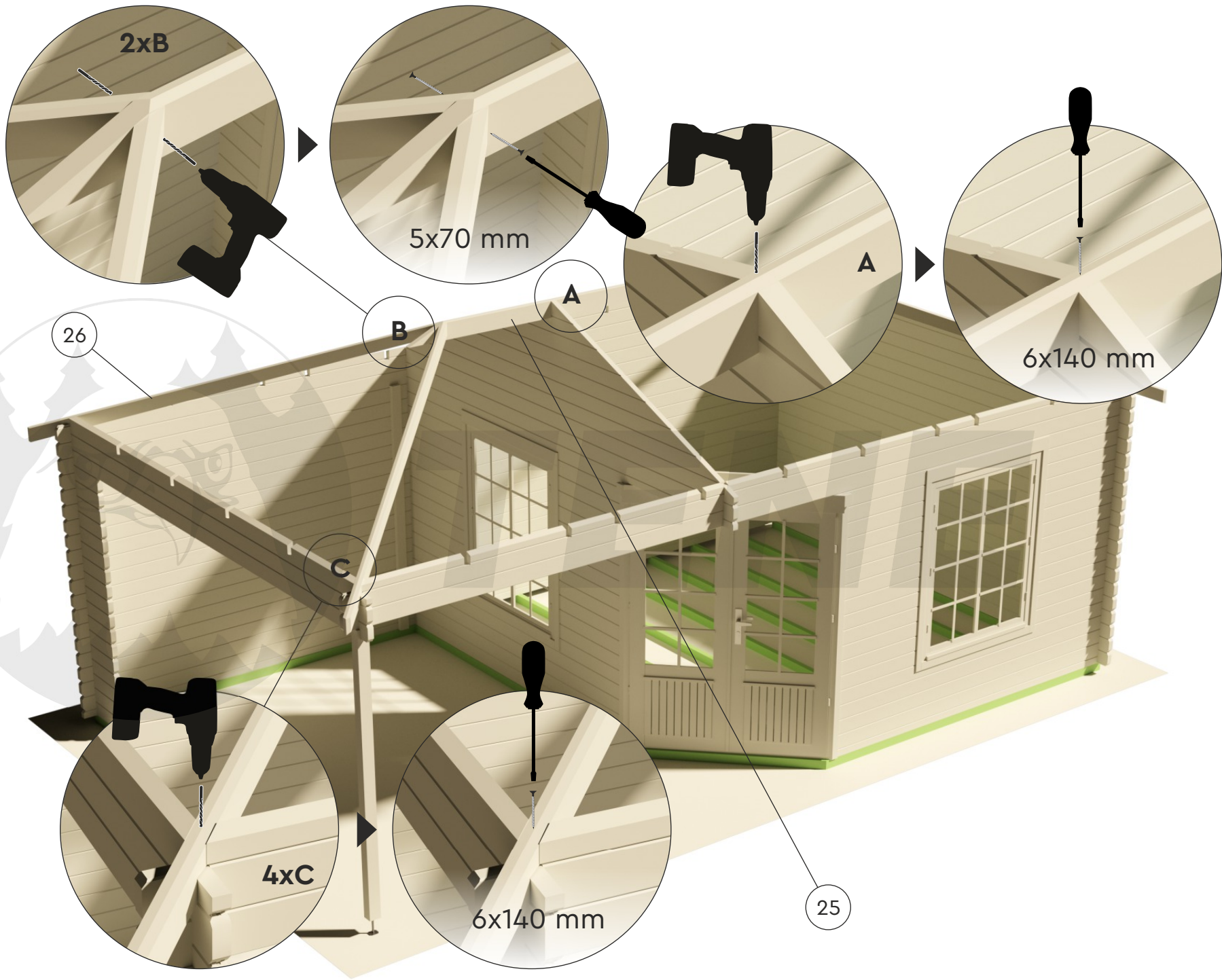

Ø 5 mm

Ø 4 mm

6x140 mm

5x70 mm



SICILIA 40

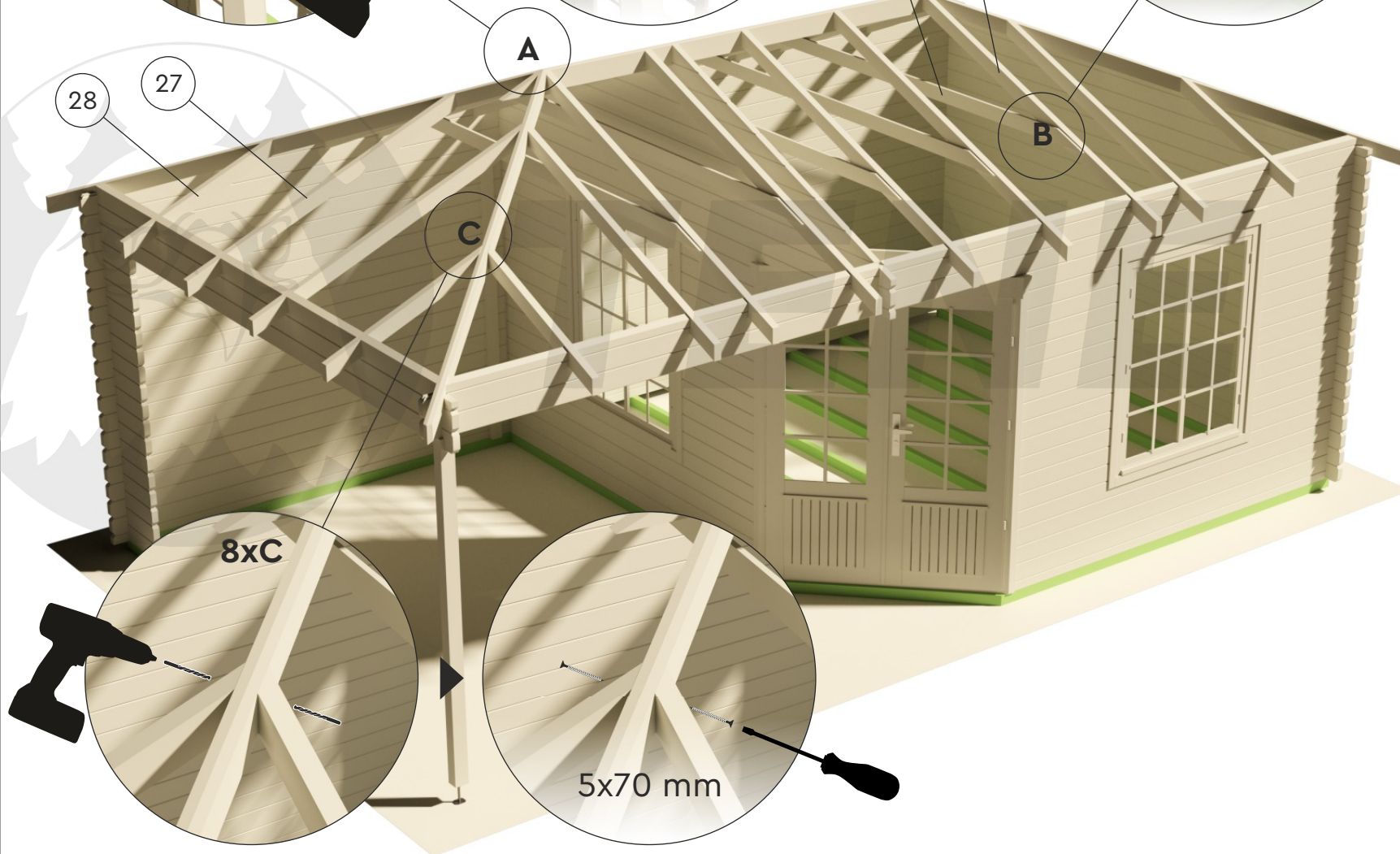
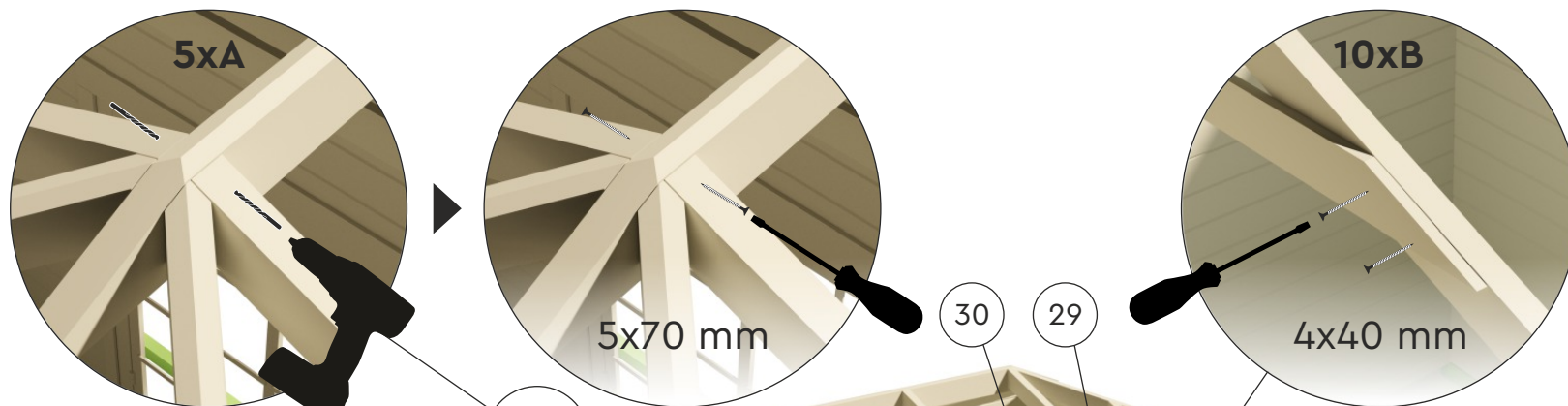

SICILIA 40

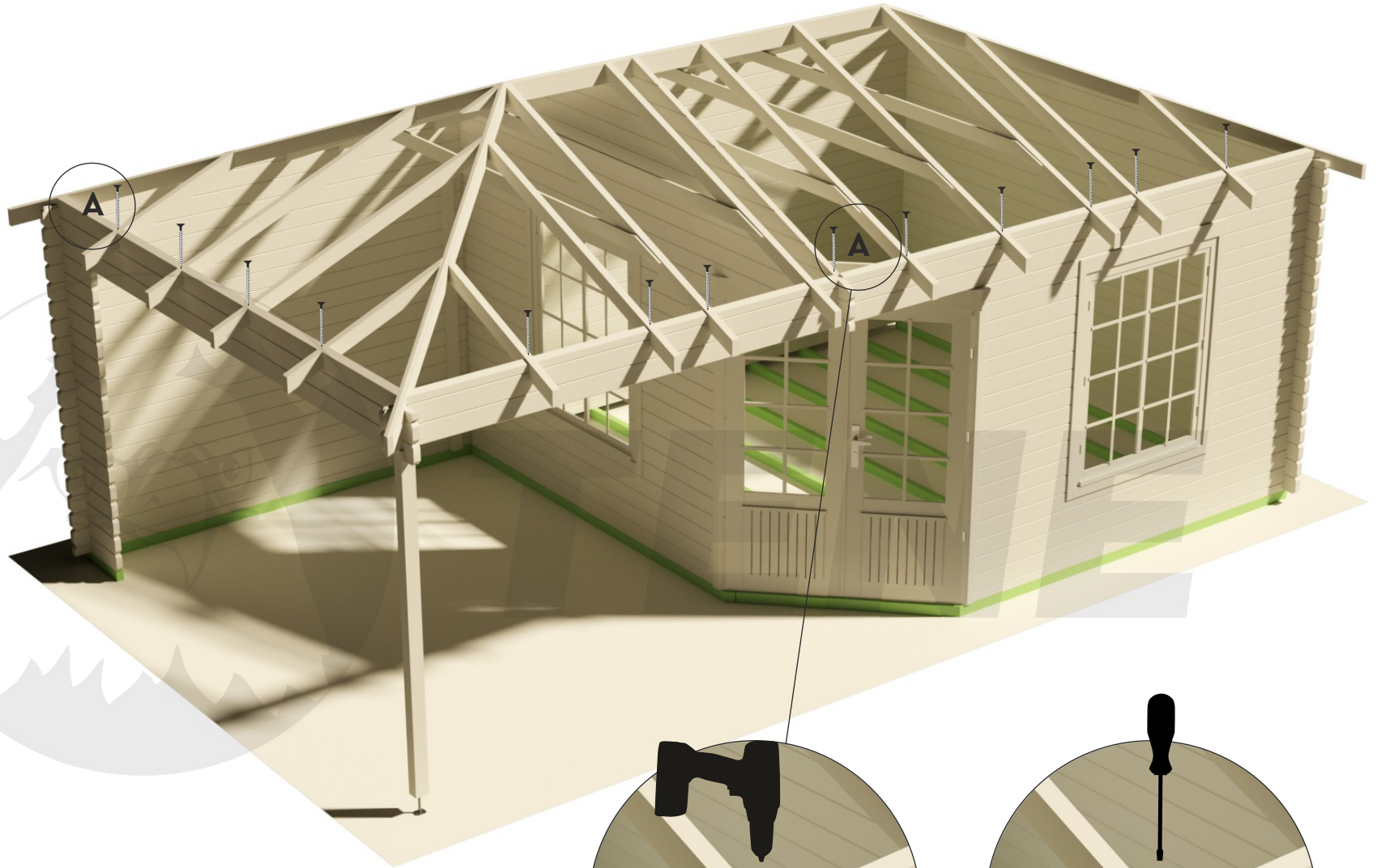

Ø 5 mm

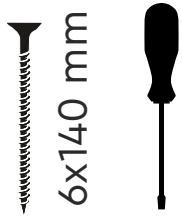

6x140 mm



26xA

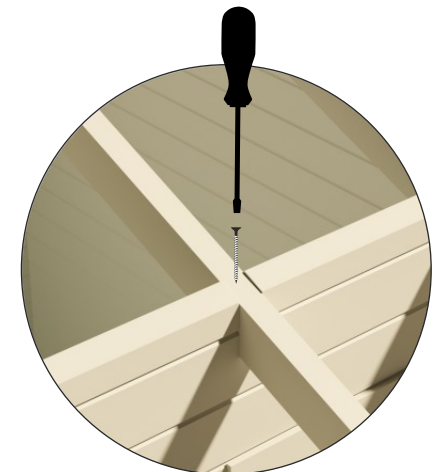

SICILIA 40

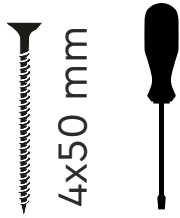
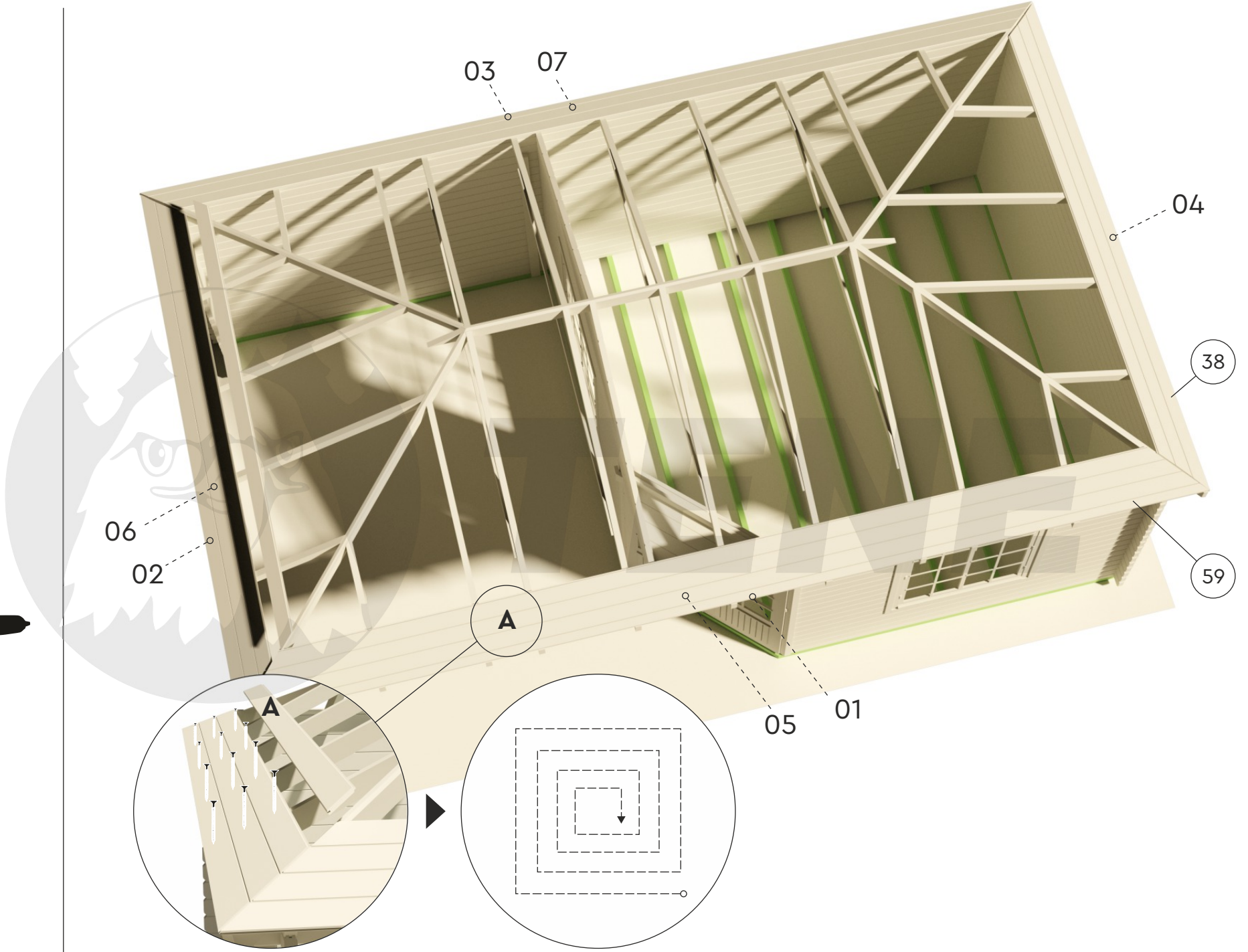

SICILIA 40

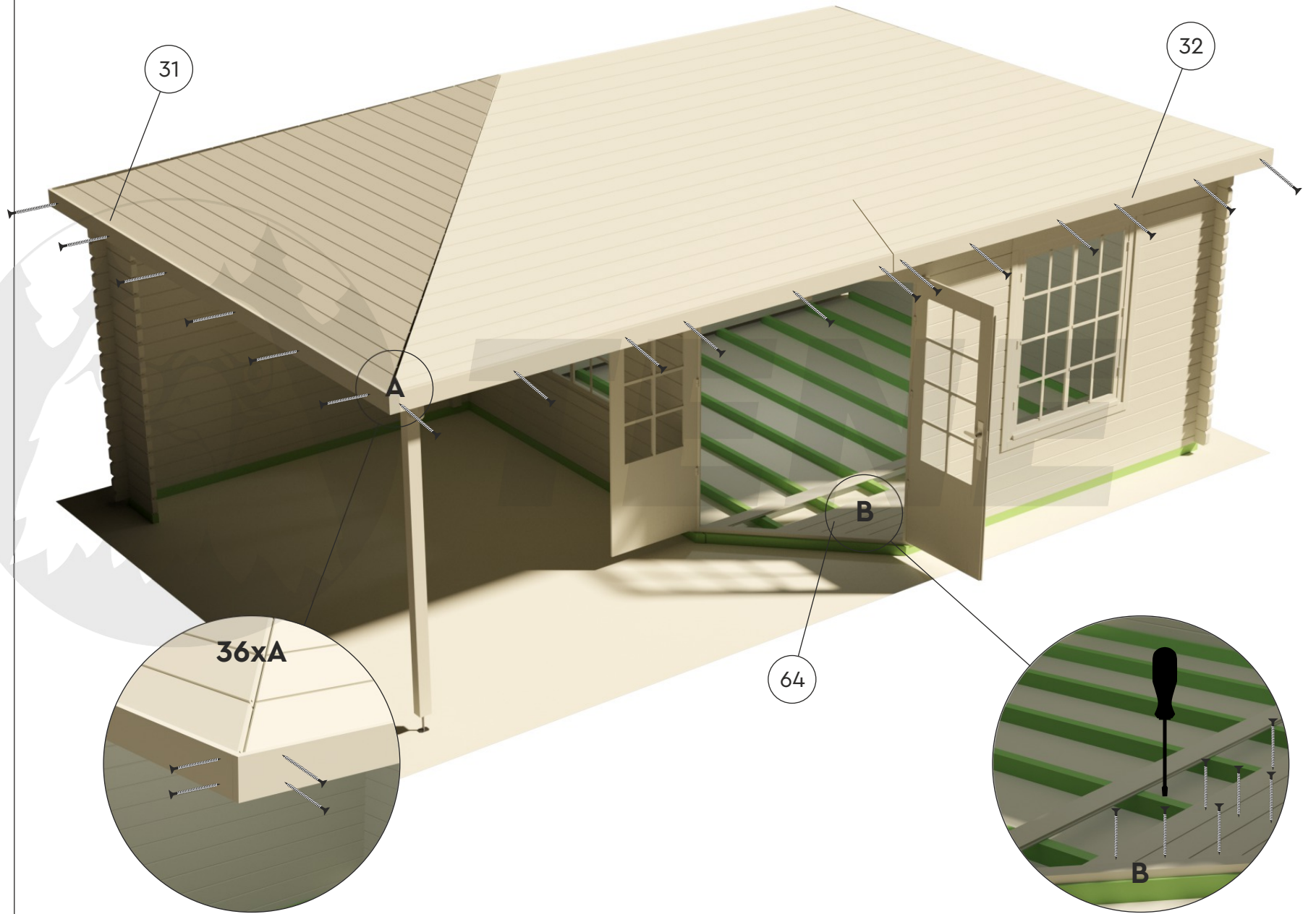
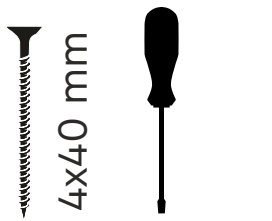

SICILIA 40

