

VICTORIA B 28

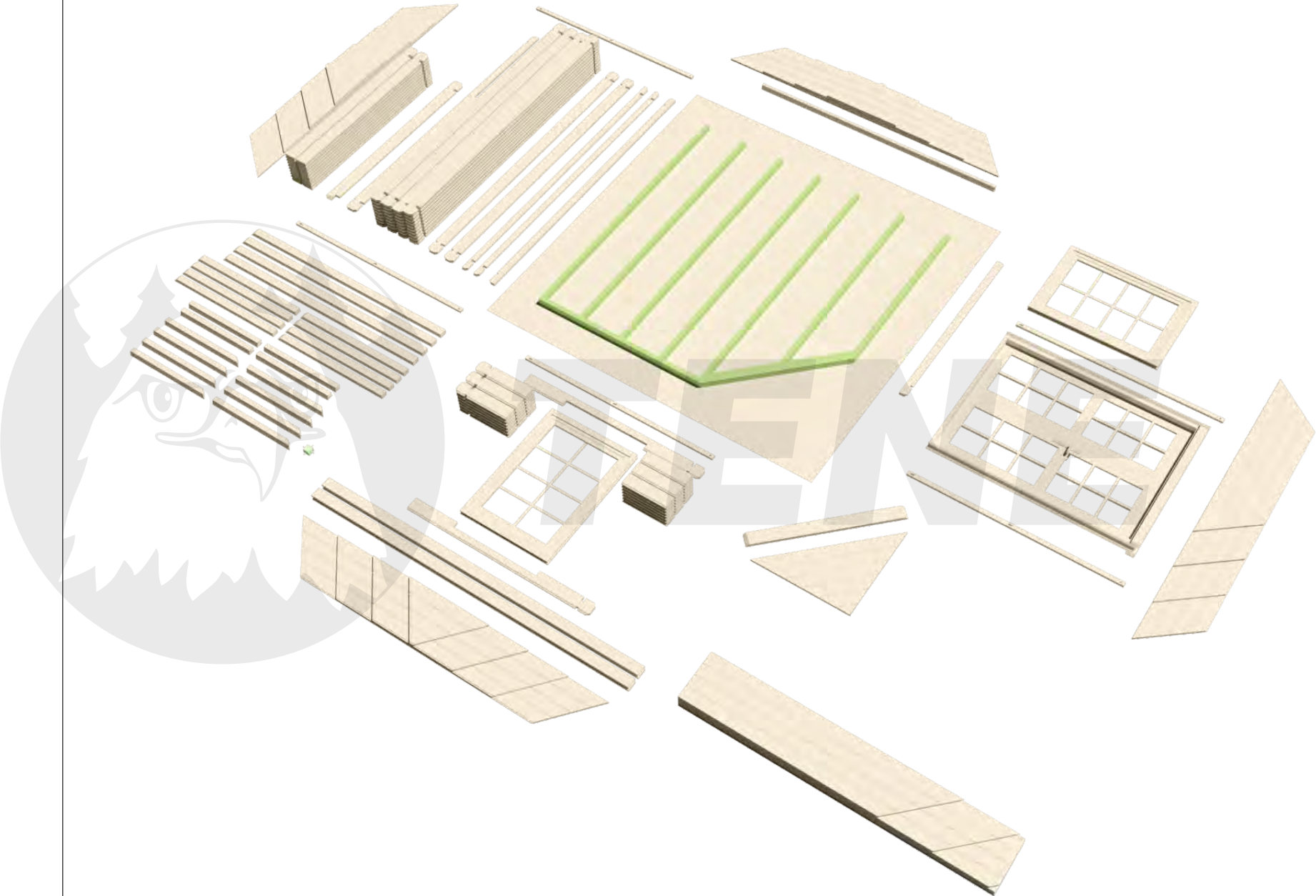

VICTORIA B 28

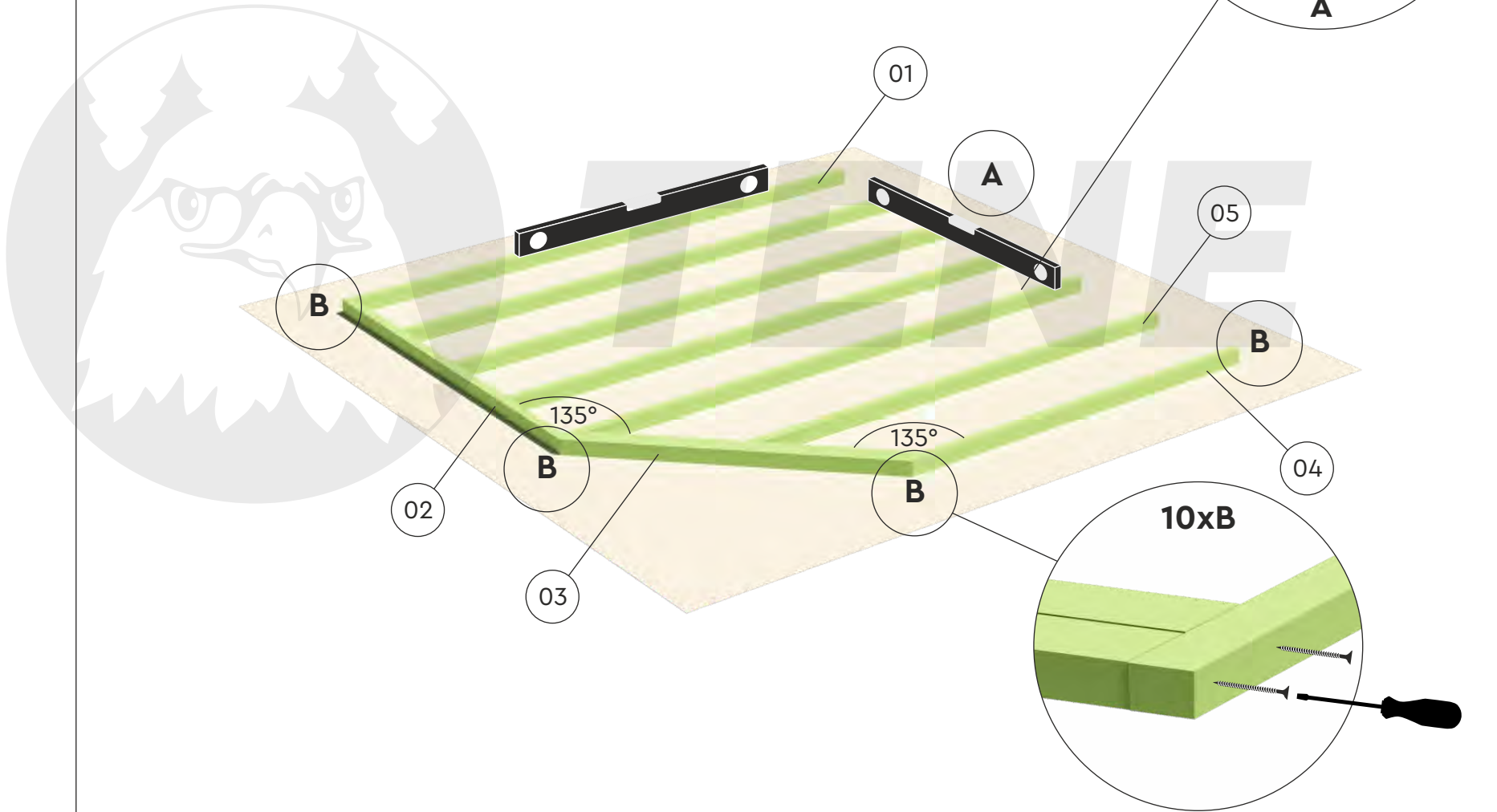
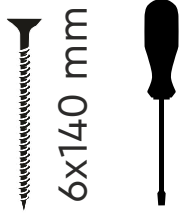

VICTORIA B 28

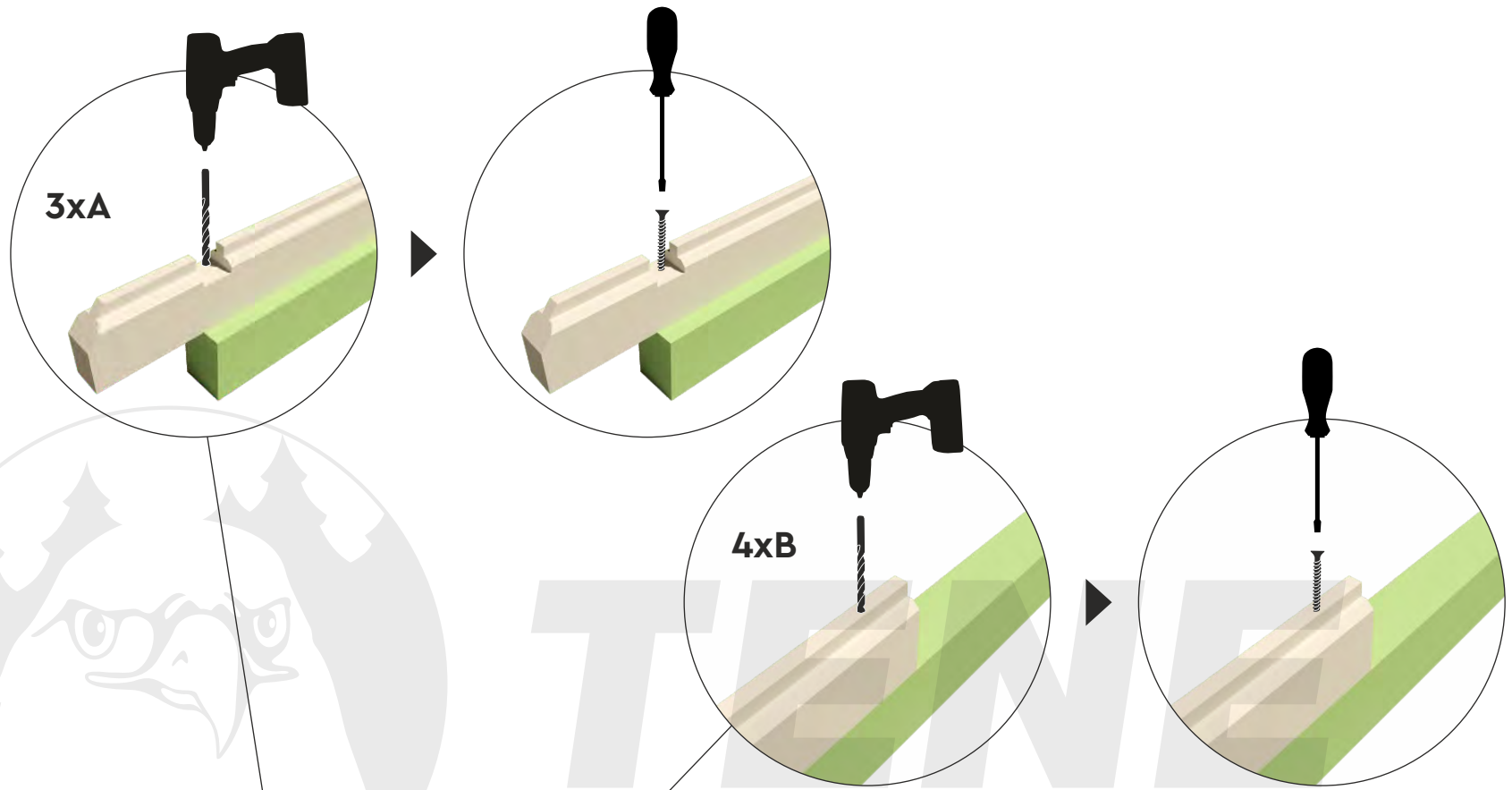

Ø 4 mm

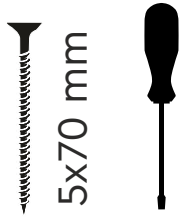

5x70 mm

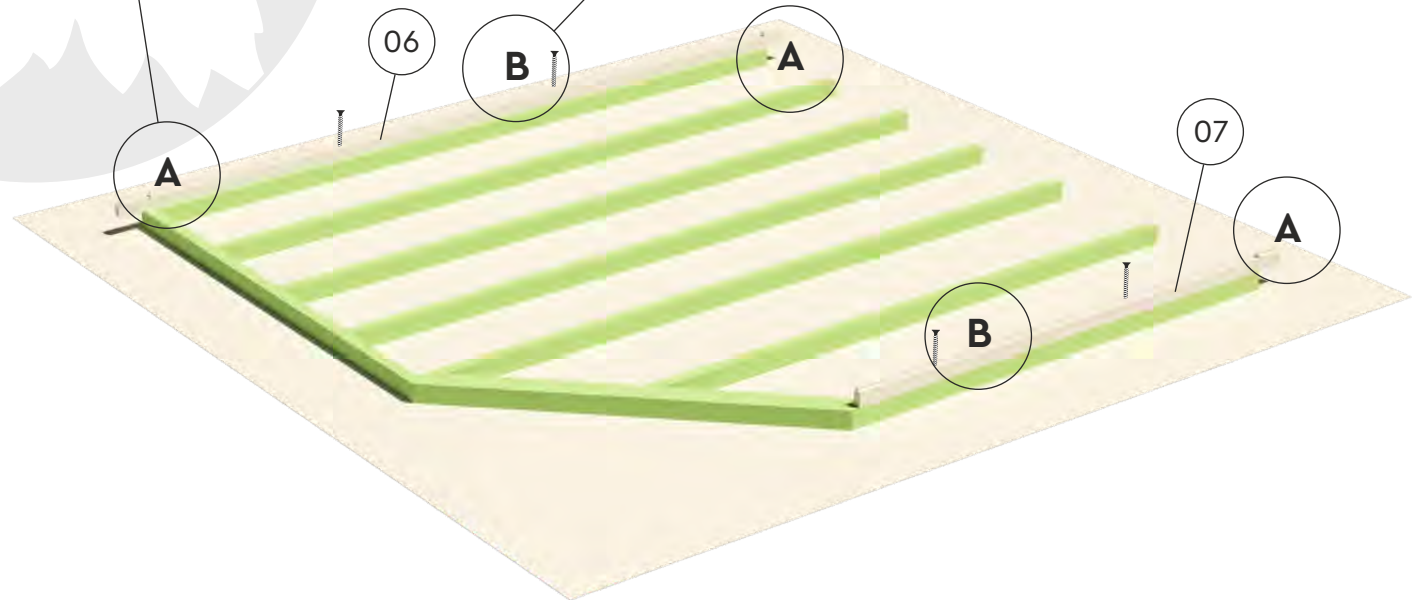

VICTORIA B 28

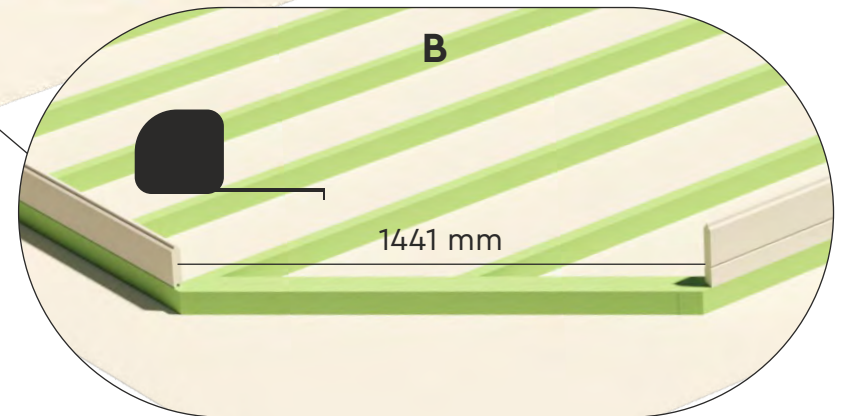
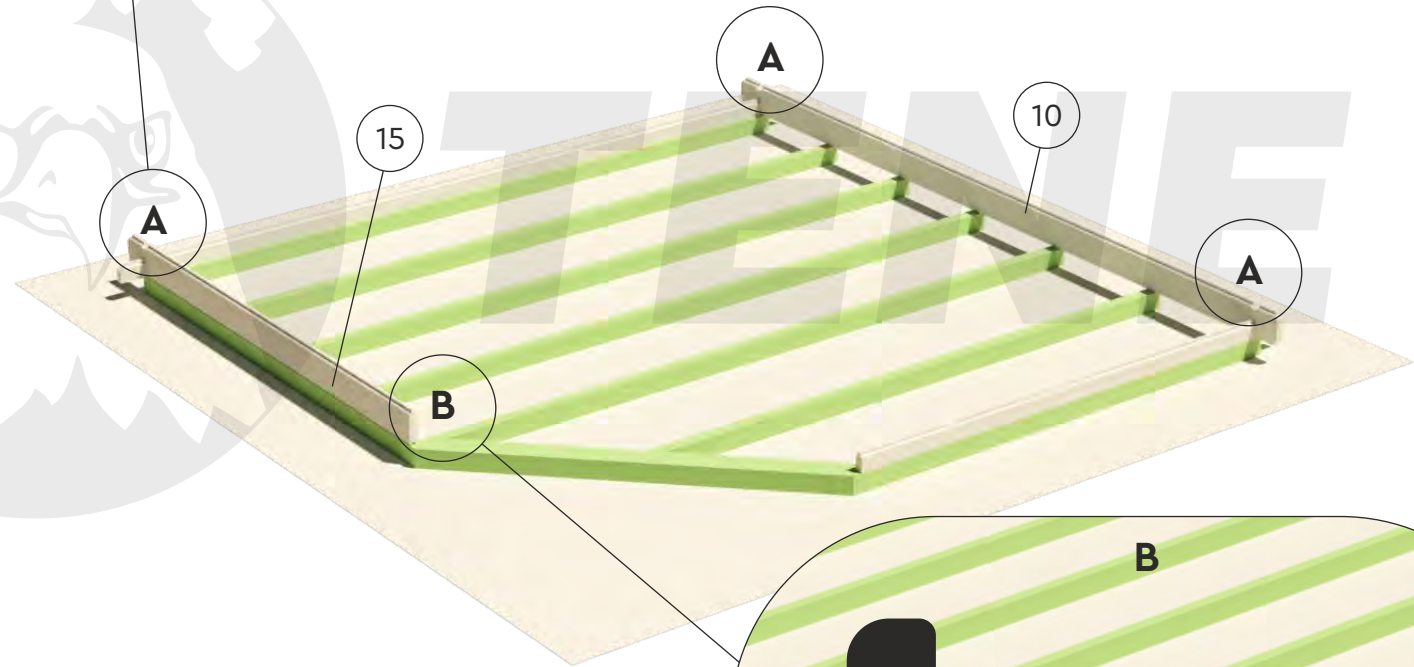
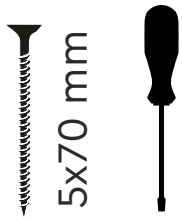
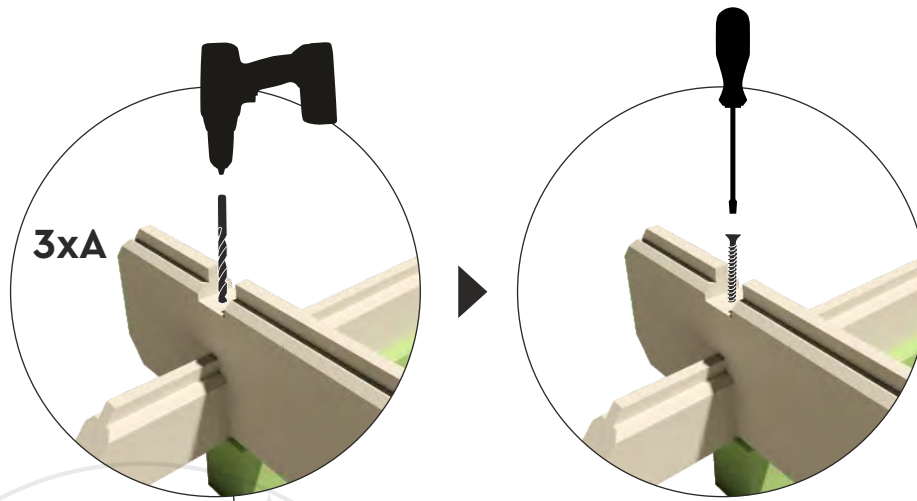

VICTORIA B 28

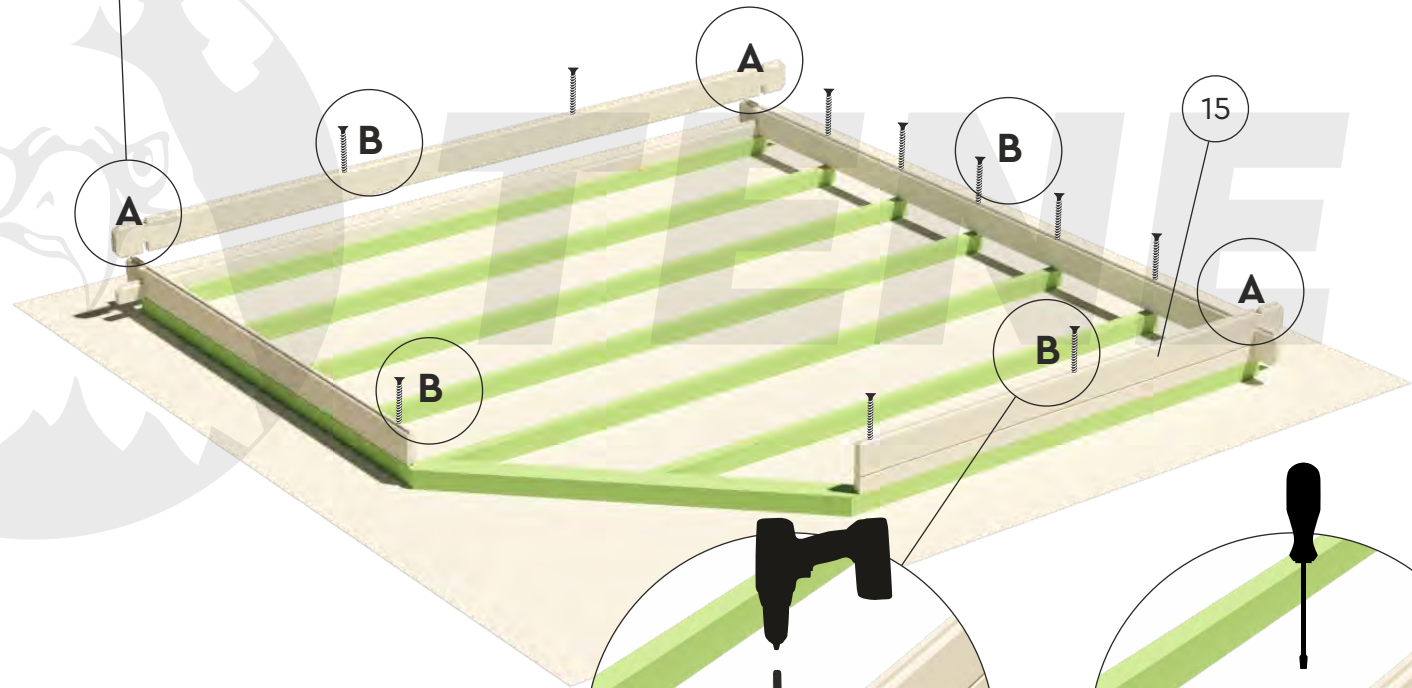
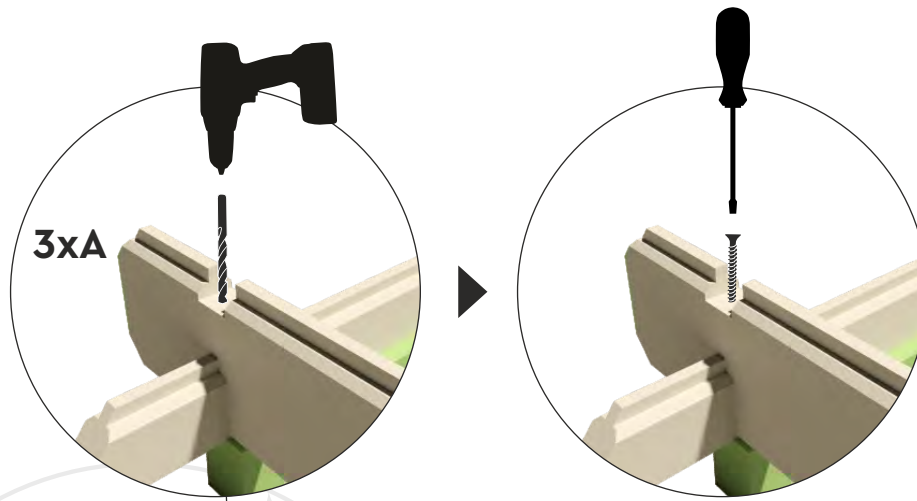

Ø 5 mm

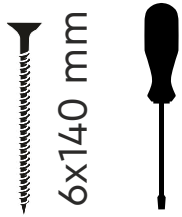

6x140 mm



VICTORIA B 28

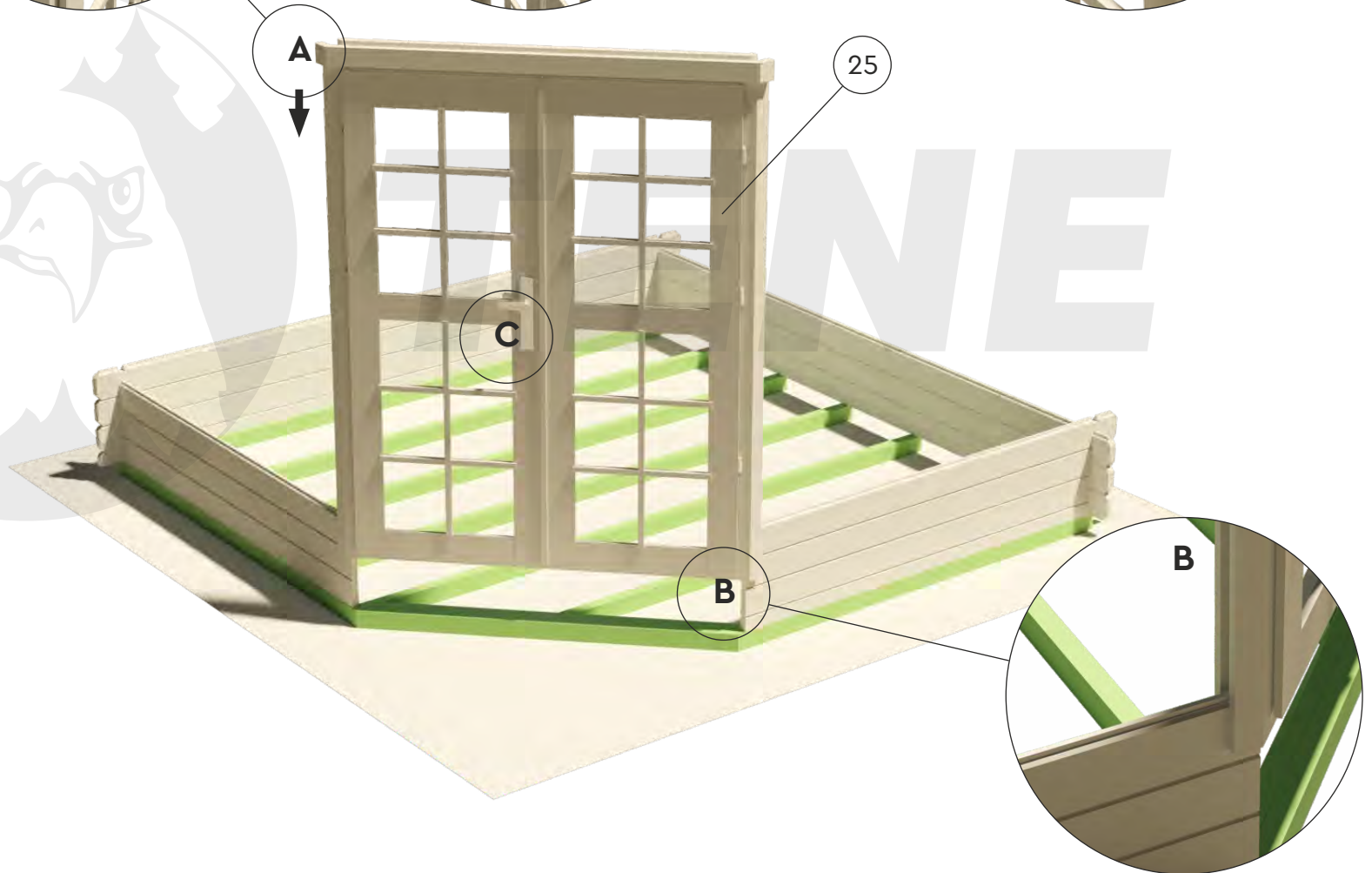
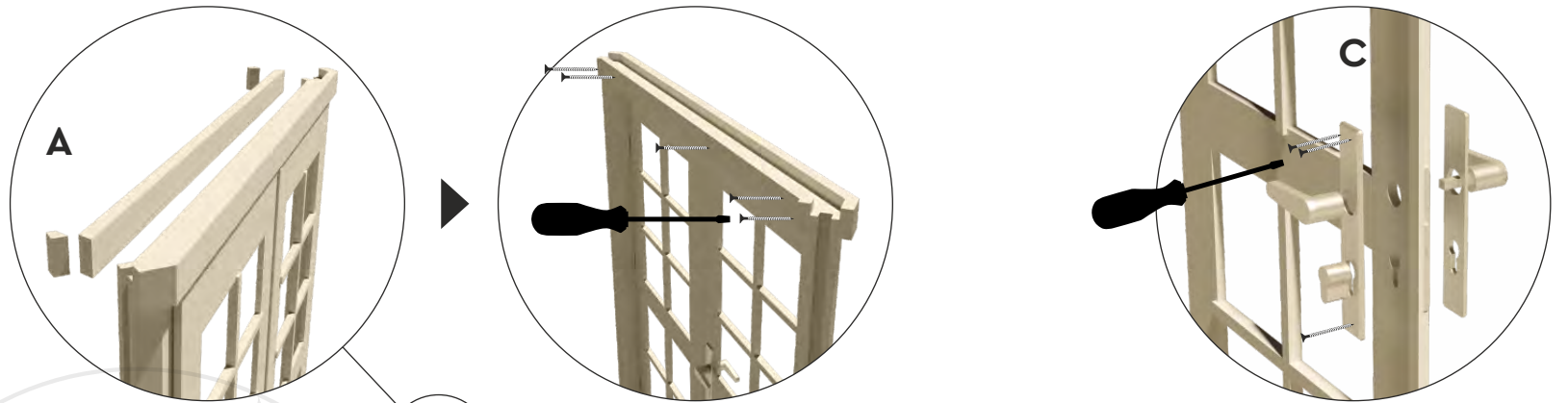

VICTORIA B 28

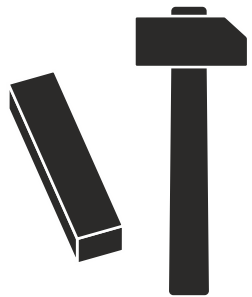
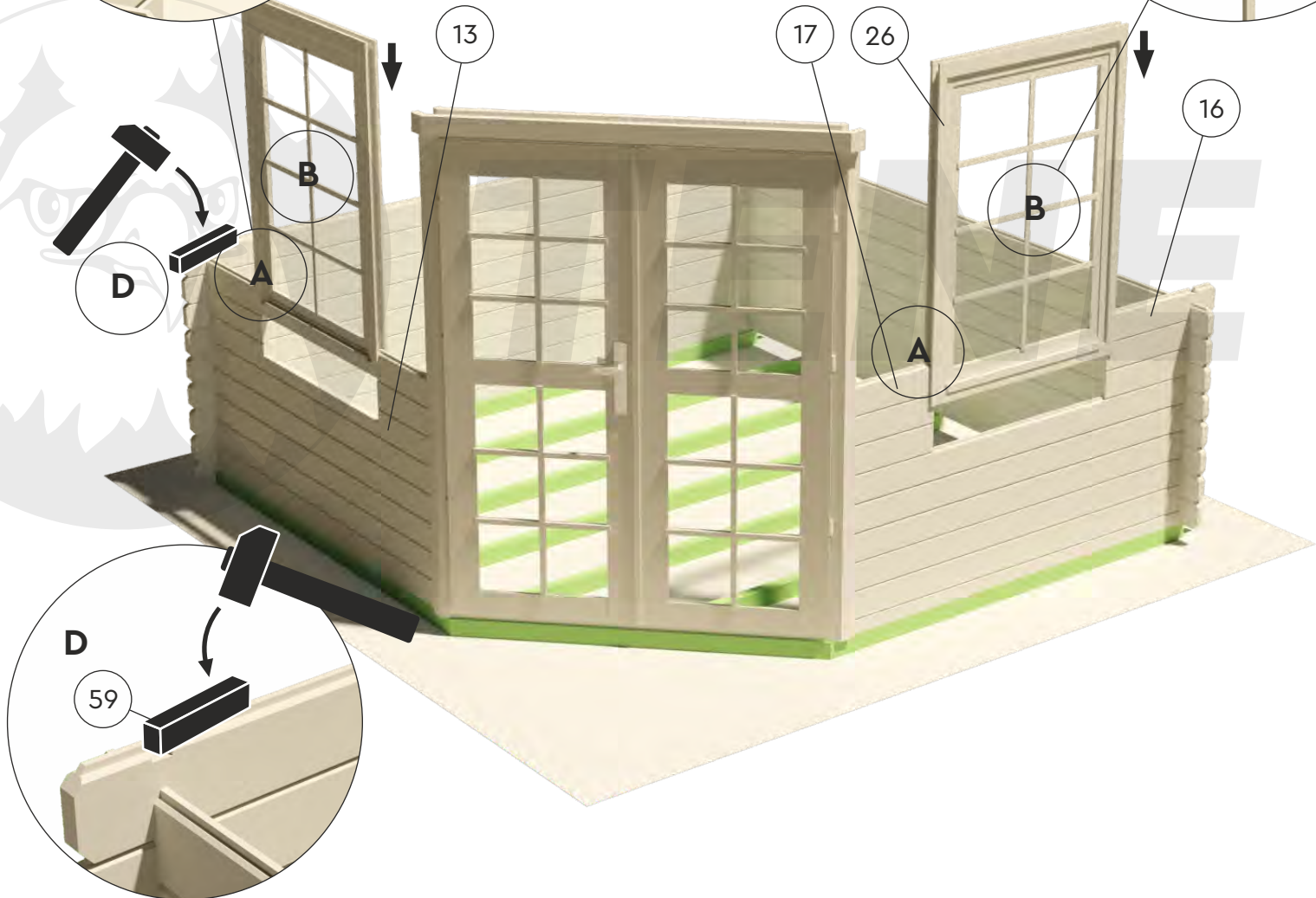
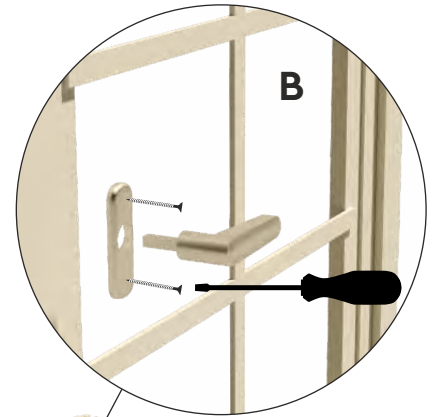
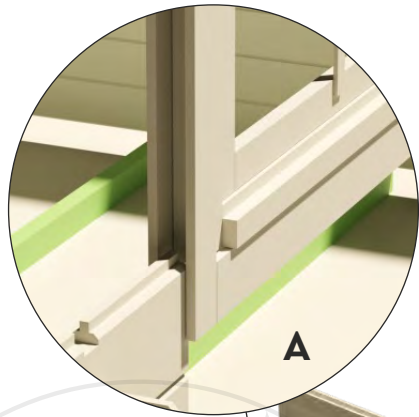

VICTORIA B 28

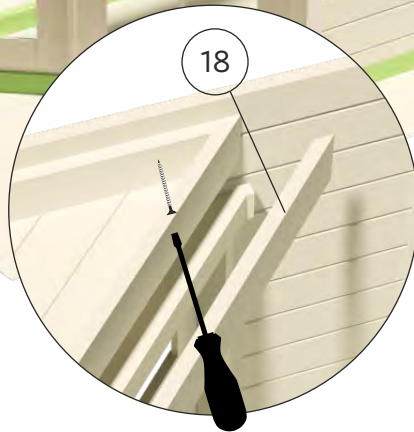
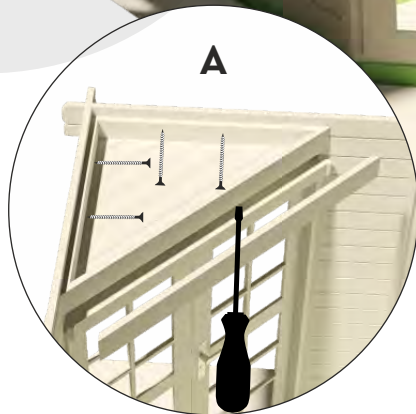
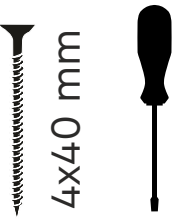
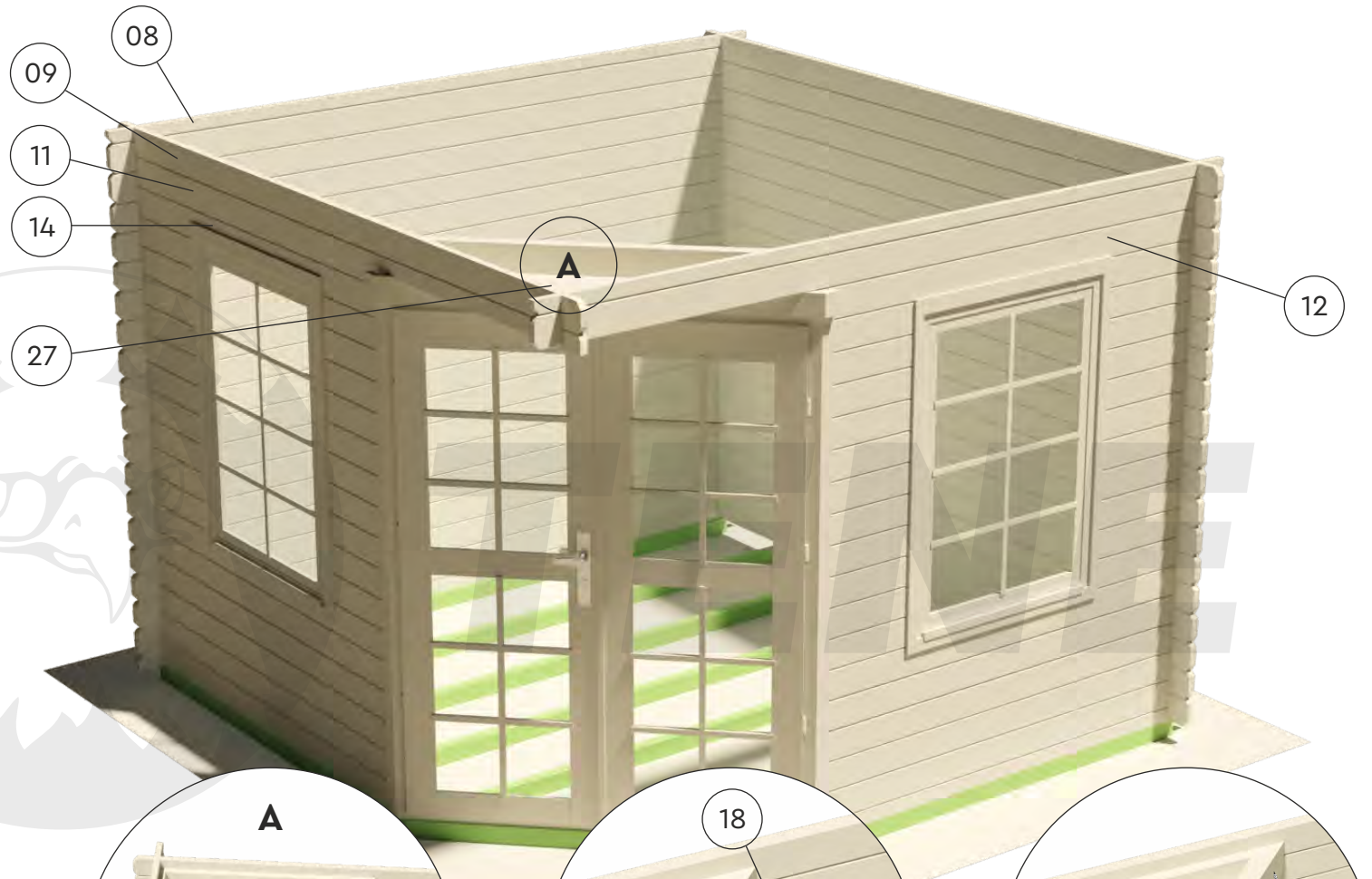

VICTORIA B 28

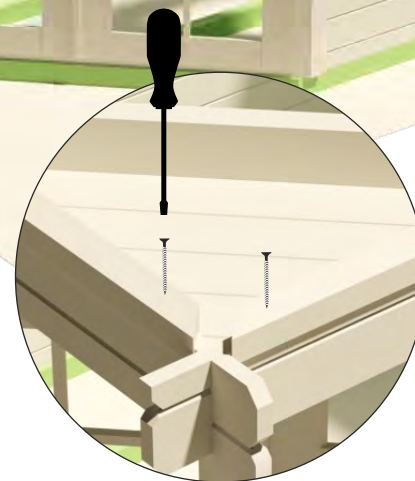
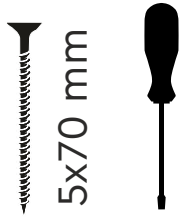
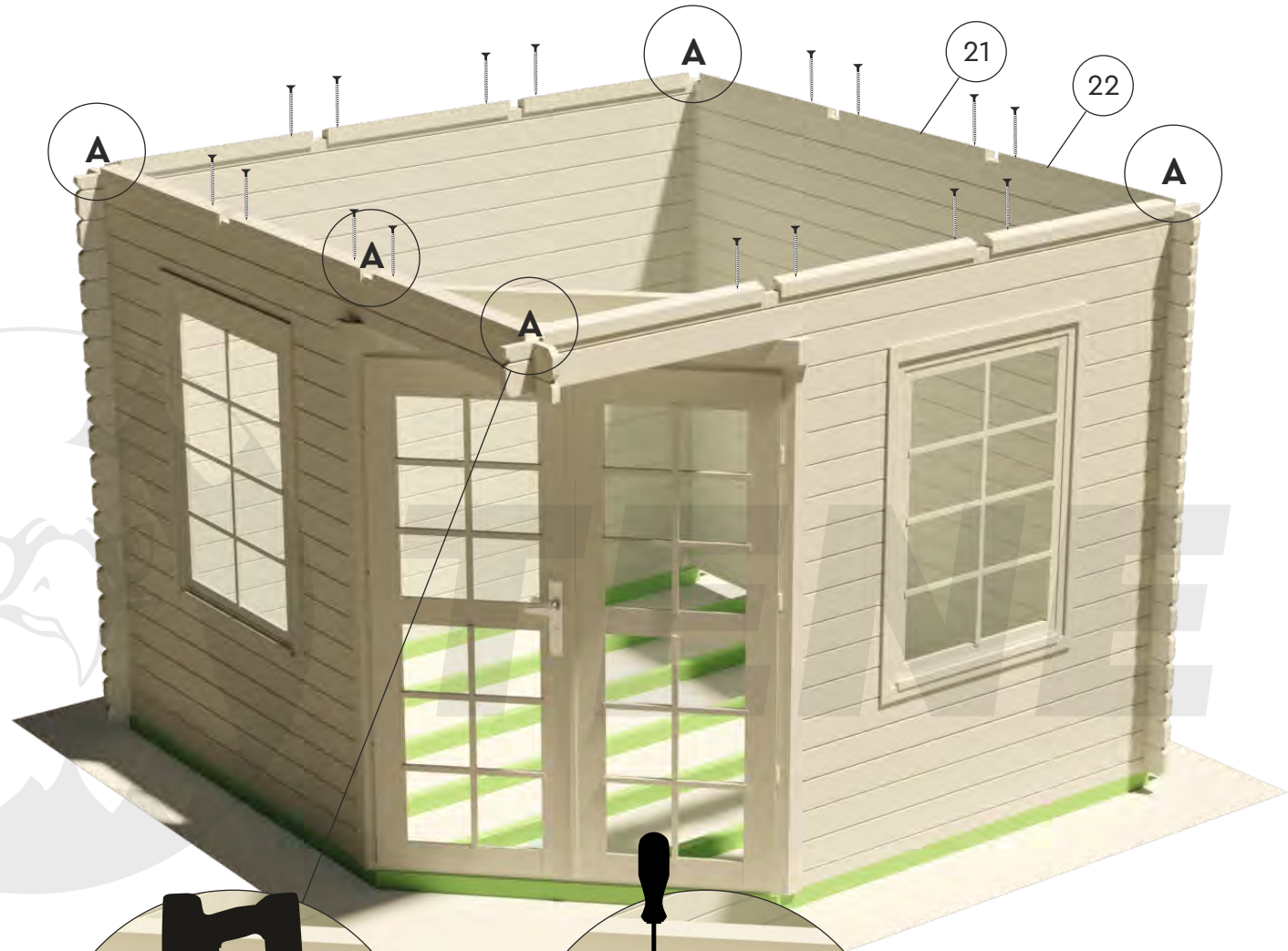

VICTORIA B 28

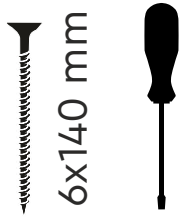
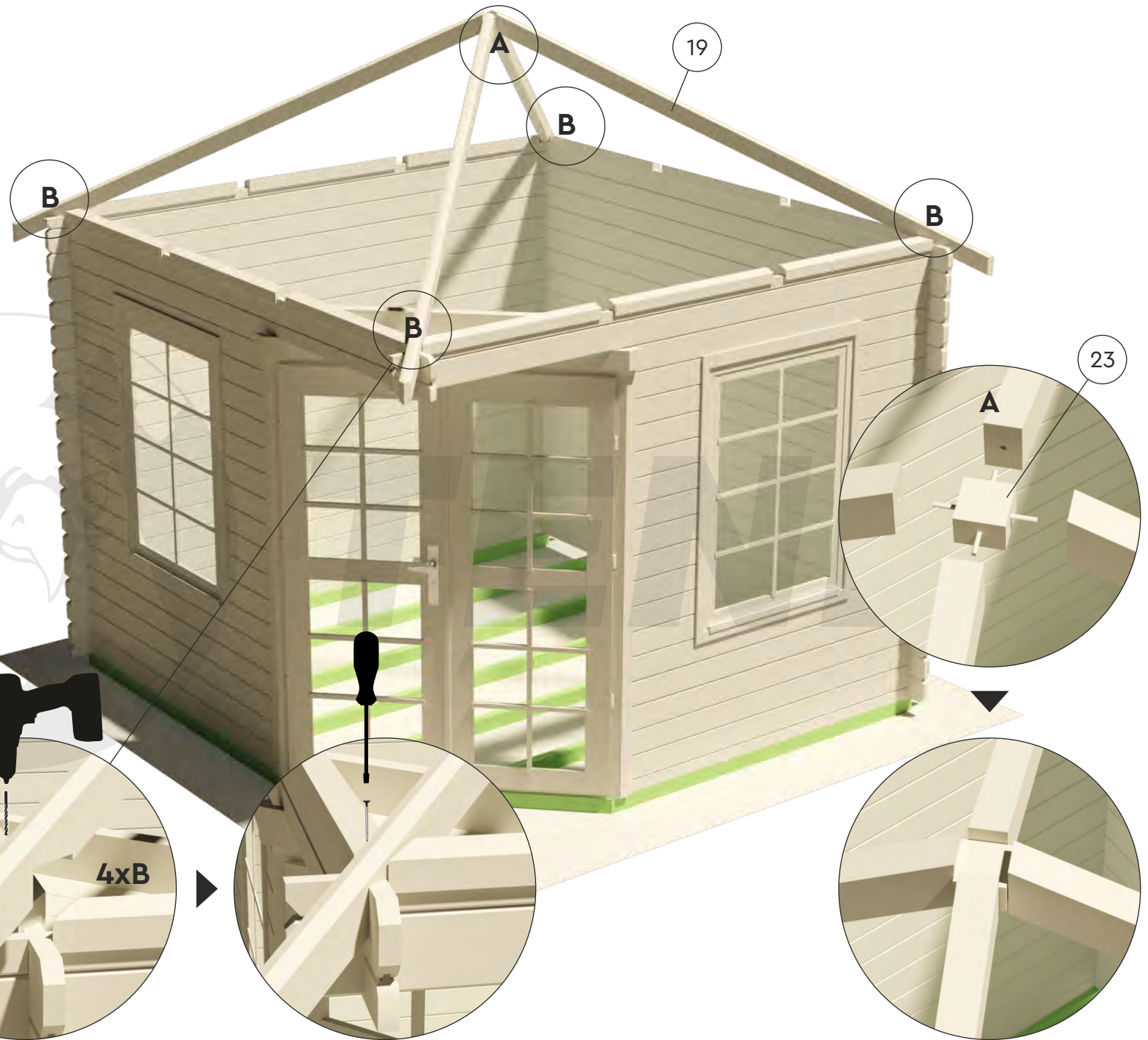

VICTORIA B 28

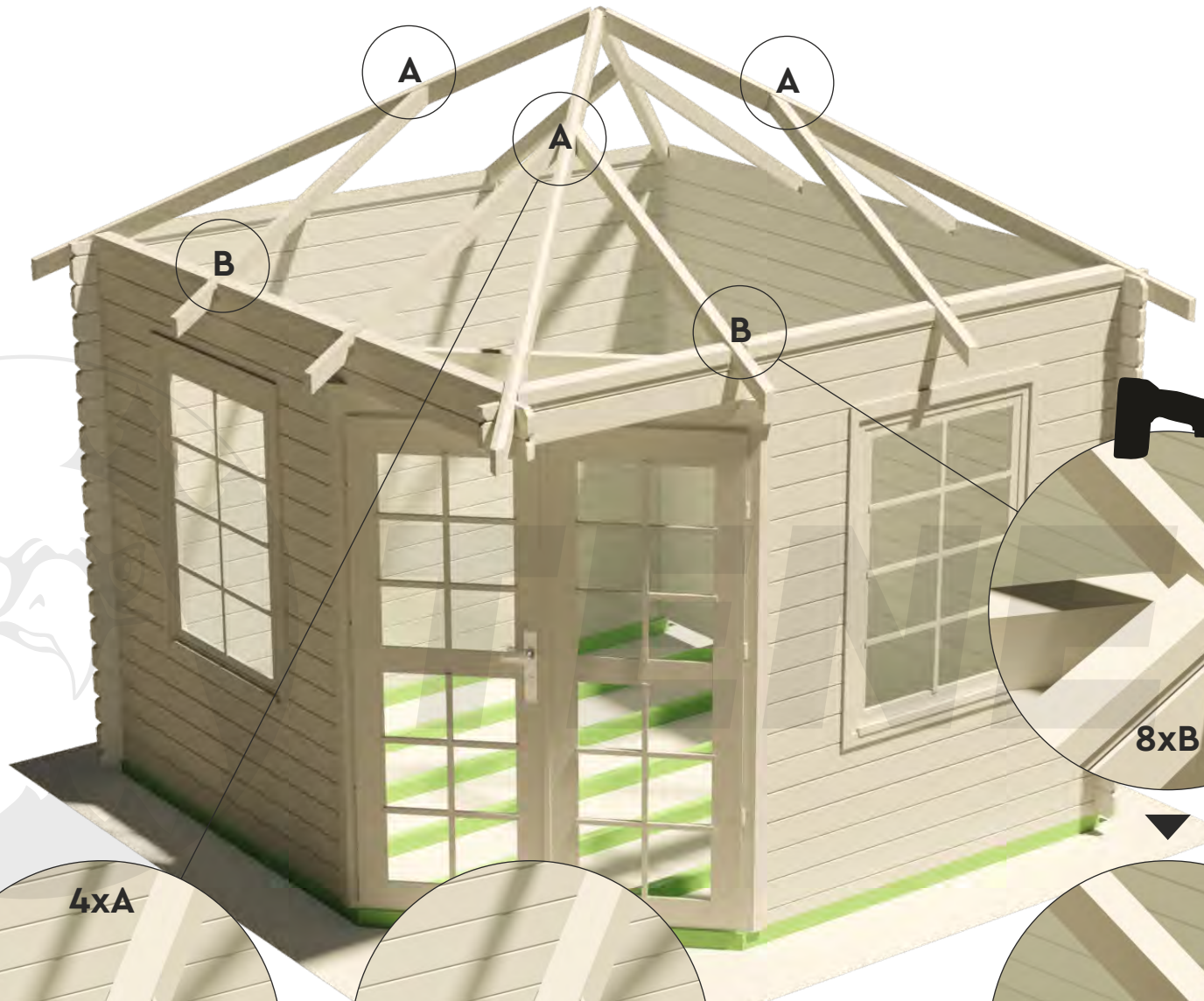

ø 5 mm



ø 4 mm



6x140 mm



5x70 mm

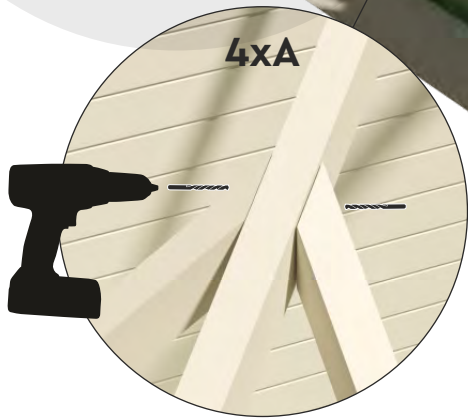

4xA

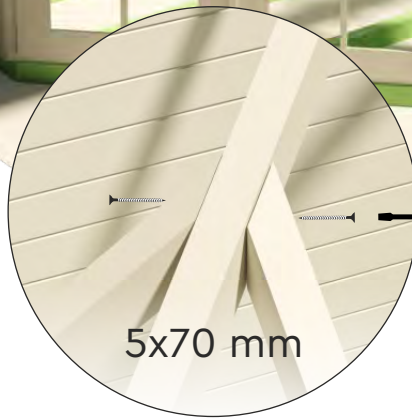

5x70 mm

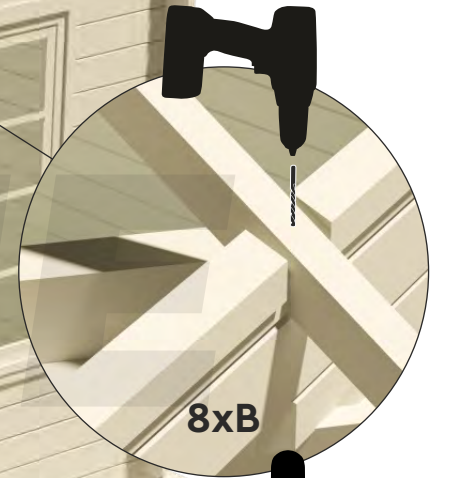

8xB

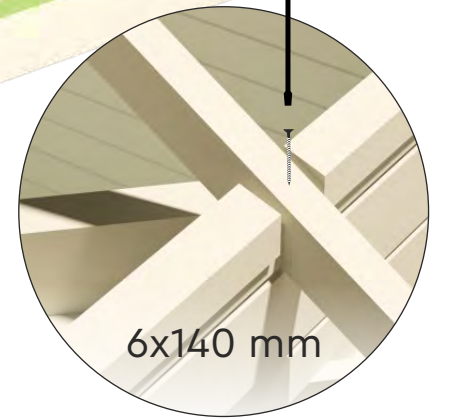

6x140 mm

VICTORIA B 28

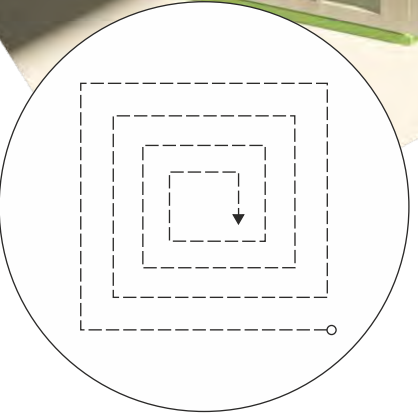
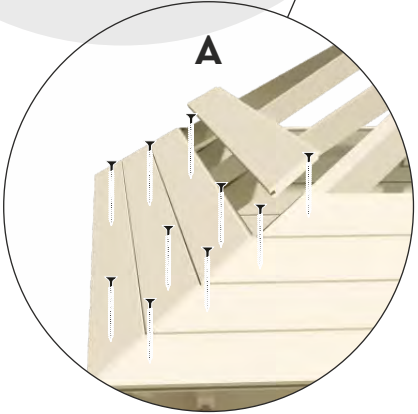
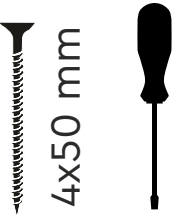
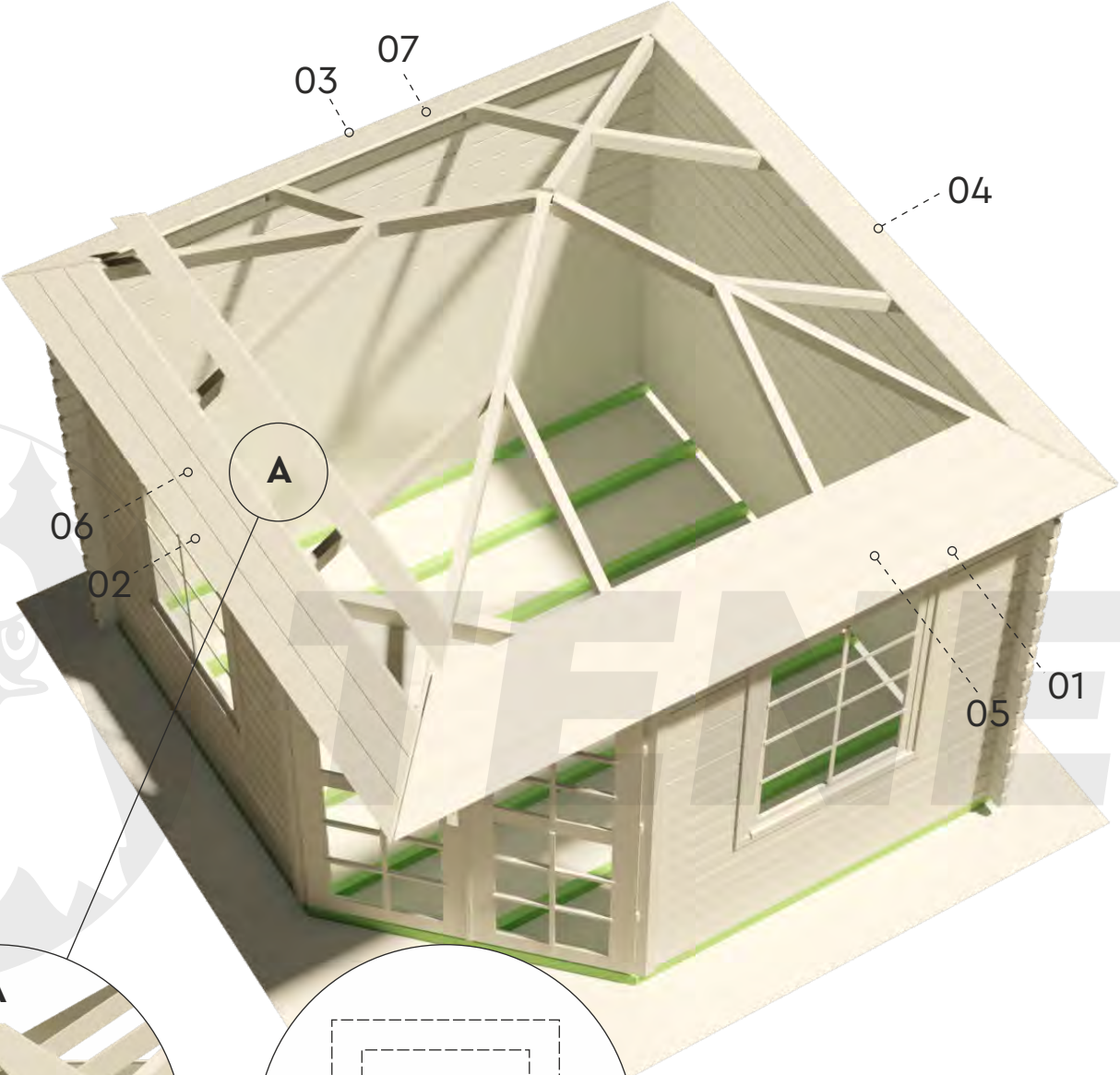

VICTORIA B 28

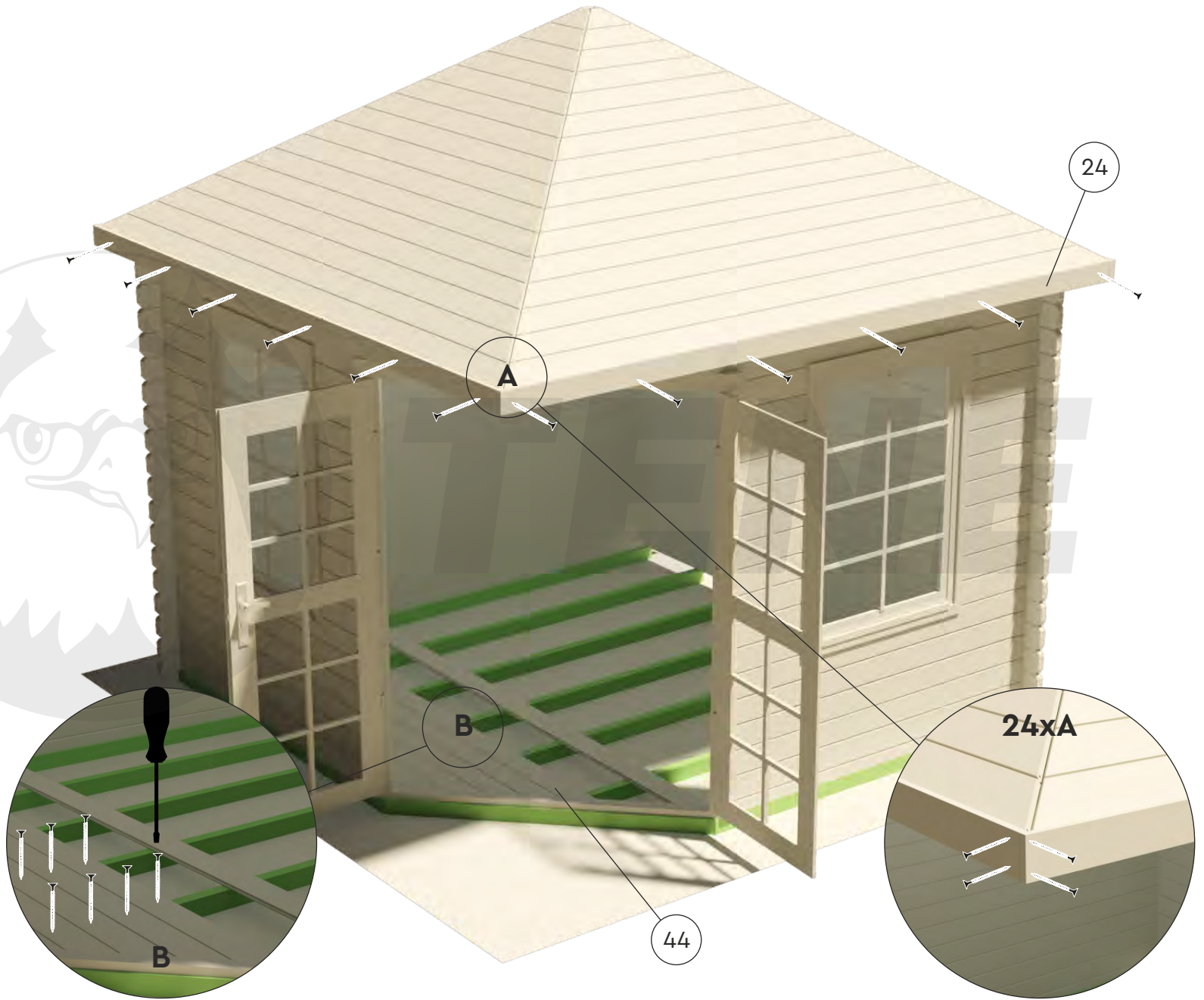
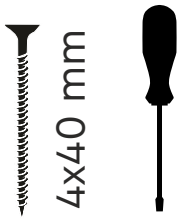

VICTORIA B 28

